

Massivsauna

ALASKA

MINI

160 x 110 x 204 cm

MONTAGEANLEITUNG
Deutsch



DE

EN

FR

IT

PL

PT

Inhaltsverzeichnis

1. Montage Vorbereitung	3
1.1. Benötigtes Werkzeug	4
1.2. Wartung und Reinigung	5
1.3. Entsorgung	5
1.4. Garantie	5
1.5. Stückliste ALASKA MINI	7
2. Montage der Kabine	9
2.1. Montage des Bodenrahmens	9
2.2. Montage der Wandelemente	10
2.3. Montage Dach	17
2.4. Montage Lüftungsschieber	19
2.5. Montage Inneneinrichtung	19
2.6. Montage Zubehör	25
2.7. Montage Glastür	27
2.8. Montage Dachkranz	29
2.9. Montage Dachabdeckleiste	30
3. Grundriss	31
3.1. Grundriss „rechts“	31
3.2. Grundriss „links“	32
3.3. Änderungen bei Montage Grundriss „links“	33

1. Montage Vorbereitung

Lesen Sie diese Montageanleitung gut durch und bewahren Sie sie in der Nähe der Sauna auf. So können Sie jederzeit Produktinformationen nachlesen.



Sie finden diese Montageanleitung auch im Downloadbereich unserer Webseite auf www.sentiotec.com/downloads.

Wichtige Hinweise:

- Kontrollieren Sie, bevor Sie mit der Arbeit beginnen, anhand der Stückliste, ob alle Einzelteile auch tatsächlich mitgeliefert wurden. Sollten Einzelteile ausnahmsweise fehlen, benachrichtigen Sie spätestens 14 Tage nach Erhalt der Kabine Ihren Händler.
- Der Raum, in dem die Saunakabine montiert wird, muss trocken sein und eine entsprechende Luftzirkulation gewährleisten.
- Der Fußboden muss waagrecht und eben sein, bevorzugt Stein- oder Fliesenboden.
- Für die Montagearbeiten der Kabine wird eine Mindestraumhöhe von 230 cm benötigt.
- Es muss ein Wandabstand von mindestens 5 cm eingehalten werden.
- Die Innen zu verwendenden Holzteile dürfen nicht mit Imprägniermittel behandelt werden.
- Für die Montage benötigen Sie einen Helfer.
- Holz ist ein Naturprodukt, das trotz guter Lagerung aufquellen, schwinden oder sich verziehen kann. Aus diesem Grund kann es vorkommen, dass bei der Montage etwas Kraft aufgebracht werden muss.
- Alle Verschraubungen müssen vorgebohrt werden.

Achtung!

Der Elektroanschluss darf nur durch eine Elektrofachkraft oder eine vergleichsweise qualifizierte Person ausgeführt werden.

1.1. Benötigtes Werkzeug

- Hammer und Beilageholz oder einen Gummihammer
- Akkuschauber mit Bits für Kreuzschrauben und Torx
- Rollmaßband
- Bohrer mit Durchmesser 3 mm, 10 mm, 20 - 30 mm (für Stromkabel Saunaofen)
- Wasserwaage
- Innensechskant-Schlüssel 1,5 mm
- Universalmesser
- Leiter
- Feinsäge



Dieses Symbol kennzeichnet Tipps und nützliche Hinweise



Vorbohren



Ablängen auf Naturmaß mit Feinsäge



Überprüfung des rechten Winkel:

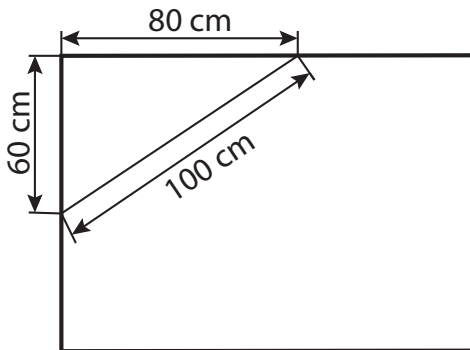

1.2. Wartung und Reinigung

- Die Sauna sollte mit einem feuchten Tuch gereinigt werden. Verwenden Sie nur warmes Wasser - keine Reinigungsmittel.
- Wird die Sauna längere Zeit nicht benutzt, empfehlen wir, die Kabine einmal im Monat aufzuheizen.

1.3. Entsorgung



- Entsorgen Sie die Verpackungsmaterialien nach den gültigen Entsorgungsrichtlinien.
- Altgeräte enthalten wiederverwendbare Materialien, aber auch schädliche Stoffe. Geben Sie Ihr Altgerät deshalb auf keinen Fall in den Restmüll, sondern entsorgen Sie das Gerät nach den örtlich geltenden Vorschriften.

DE

1.4. Garantie

Auf alle unsere Massiv- und Elementkabinen der Linie sentiotec sauna und sentiotec infra leisten wir fünf Jahre Garantie im Privatbereich. Bei gewerblicher Nutzung beläuft sich die Garantie auf zwei Jahre. Für Kabinen der Linie hotline beträgt die Garantie zwei Jahre.

Voraussetzung für diese Garantieleistung:

- Die zugehörige Rechnung wird vorgelegt,
- eine ausführliche Fehlerbeschreibung wird beigelegt,
- die Kabinen wurden gemäß der sentiotec Montage- und Gebrauchsanweisungen montiert,
- der Garantieanspruch geht innerhalb der Garantiezeit bei sentiotec ein.

Von der Garantie ausgenommen sind:

- Mängel oder Schäden, die durch einen nicht bestimmungsgemäßen Gebrauch entstanden sind
- Kabinen die ohne ausdrückliche Zustimmung des Herstellers verändert wurden
- Harzgallen
- Ausgelaufenes Harz
- Schäden und Verfärbungen des Holzes aufgrund unzureichender Belüftung oder durch nicht bestimmungsgemäßen Aufstellort
- Natürliche Veränderungen von Holz wie Verfärbung, Rissbildung, Schwindung, Quellen oder ähnliche, durch die natürlichen Eigenschaften des Holzes begründete, Veränderungen

Harzgallen sind kein Reklamationsgrund, da in Fichtenholz immer wieder Harzgallen vorkommen und beim Aussortieren nicht erkannt werden kann, in welcher Tiefe sich diese befinden. Wenn diese knapp unter der Oberfläche sind, bei Hitzeentwicklung aufbrechen und "ausbluten" lassen. Das ausgelaufene Harz mit einem in Aceton getränkten Lappen entfernen. Wenn lediglich Harztropfen entstehen, diese aushärten lassen und anschließend mit einem Messer vorsichtig abschaben.

Die Garantiezeit beginnt ab der Rechnungserstellung des Kabinenherstellers. Voraussetzung dafür ist die Vorlage der Originalrechnung. Sollte keine Originalrechnung vorhanden sein, dient das Herstellungsmonat, das auf dem Typenschild des Produktes vermerkt ist, als Grundlage für den Beginn der Garantiezeit. Die Garantiefrist wird durch Garantieleistungen weder verlängert noch erneuert.

Die fünfjährige Garantie ist ein Zusatz zu den Allgemeinen Geschäftsbedingungen der sentiotec GmbH.

1.5. Stückliste ALASKA MINI

Az	Bezeichnung	Maß
Bodenrahmen		
1	Bodenrahmen	156 x 9 x 4 cm
1	Bodenrahmen	108 x 9 x 4 cm
1	Bodenrahmen	102 x 9 x 4 cm
1	Bodenrahmen	64 x 9 x 4 cm
Wandelemente		
1	Lüftungselement A/B mit Multiclip	193 x 48 x 4 cm
1	Wandelement A/B	193 x 48 x 4 cm
1	Wandelement A/B mit Multiclip	193 x 48 x 4 cm
4	Wandelemente A/A mit Multiclip	193 x 48 x 4 cm
1	Elektroelement A/A mit Multiclip	193 x 58 x 4 cm
1	Element oberhalb Tür, Grundriss „rechts“	81,5 x 10,1 x 4 cm
1	Element oberhalb Tür, Grundriss „links“	81,5 x 10,1 x 4 cm
Dachelemente		
2	Dachelemente	146 x 49 x 4 cm
Ecksteher		
3	Ecksteher 90° mit Multiclip	193 x 6 x 6 cm
1	Ecksteher mit Falz vorne für Glastür mit Multiclip	202 x 6 x 7,5 cm
1	Steher für Glaselement 8 mm Nut	202 x 4,5 x 4 cm
Auflageleisten		
2	Dachauflageleisten	140 x 4 x 4 cm
2	Dachauflageleisten	100 x 4 x 4 cm
2	Dachabdeckleisten	144 x 1,2 x 4 cm
2	Dachabdeckleisten	104 x 1,2 x 4 cm
2	Bankauflageleisten	58 x 4 x 4 cm
2	Montageleisten für Banksichtblende	26 x 4 x 4 cm

Az	Bezeichnung	Maß
Inneneinrichtung		
1	Bank	147 x 62 x 9 cm
1	Fußauftrittplatte	80 x 35 x 9 cm
2	Fußauftritt Füße	43 x 33 x 4 cm
2	Fußauftritt Strebe, 2 x 45° schräg	49,5 x 8 x 2 cm
1	Rückenlehne	138 x 26 x 4 cm
1	Banksichtblende	147 x 35 x 4 cm
1	Ofenschutzgitter - Linde	62,5 x 8 x 2 cm
1	Ofenschutzgitter - Linde	37,5 x 8 x 2 cm
3	Montageleisten für Ofenschutzgitter - Fichte	7 x 2,5 x 2,5 cm
1	Kopfstütze	43 x 25 x 7 cm
1	Lampenschutzgitter	38 x 32 x 4 cm
1	Lüftungsschieber	52 x 14 x 1,5 cm
Glaselemente		
1	Glastür	191,5 x 59 x 0,8 cm
1	Glaselement	194,5 x 22,4 x 0,8 cm
Dachkranzleisten		
1	Dachkranzleiste	160 x 6 x 4 cm
2	Dachkranzleisten	115 x 6 x 4 cm
Zubehör		
1	U Alu Profil	21,1 x 1,2 x 1,5 cm
1	Türgriff Set Holz/Niro	
1	2 Türbänder 8653-02	
1	Türmagnet, Überschublech	
1	Saunaleuchte	
1	Schablone für Multiclip Montage	
1	3 Lfm. Silikonkabel 5 x 2,5mm ²	
1	3 Lfm. Silikonkabel 3 x 1,5mm ²	
1	Montagematerialset	
1	Montageanleitung	

2. Montage der Kabine

Die Kabine kann „rechts“ oder „links“ aufgebaut werden, beachten Sie dazu die Grundrisspläne auf Seite 31 und Seite 32.

2.1. Montage des Bodenrahmens



2.2. Montage der Wandelemente

Die Ecksteher werden mittels „Multiclips“ mit den Wandelementen verbunden. Die weiteren Wandelemente sind mit Nut und Feder verbunden und werden miteinander verschraubt.



A bezeichnet immer die Sichtseite, dies ist auf der Oberseite der Wandelemente gekennzeichnet.

Achtung!

In weiterer Folge wird die Montage für Grundriss „rechts“ beschrieben. Änderungen betreffend Montage für Grundriss „links“ - siehe Seite 33.

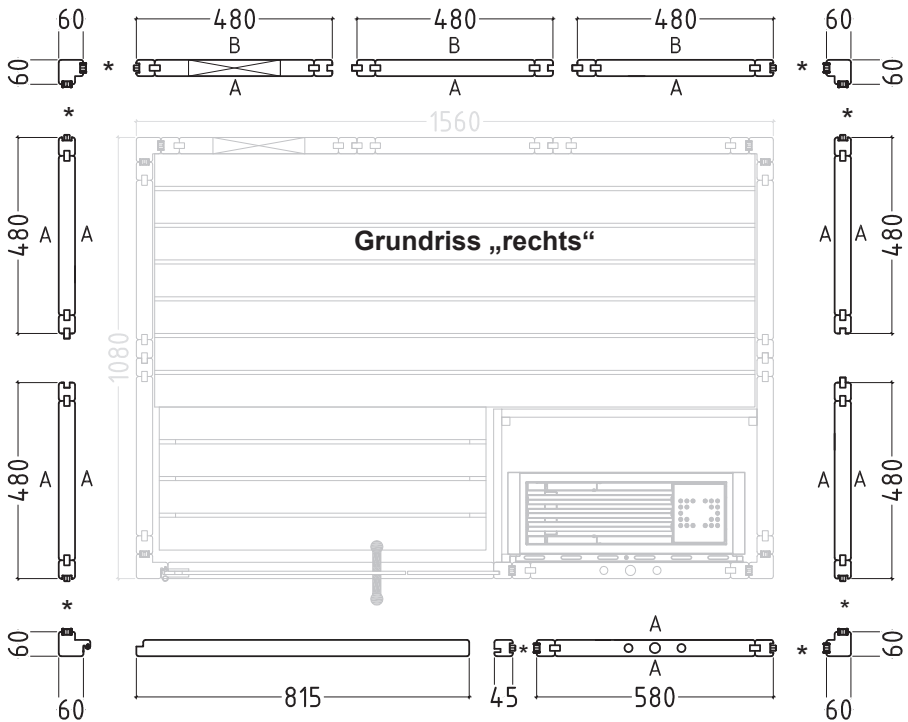

* Multiclips

Montage Ecksteher mit Wandelement

Montieren Sie die Wandelemente mit den Eckstechern am Boden vor und setzen Sie diese Ecken dann auf den Bodenrahmen auf.

Stecken Sie den Ecksteher von oben nach unten auf die Wandelemente. Achten Sie dabei auf die korrekte Ausrichtung der „Multiclips“ (siehe unten). Der Ecksteher muss bündig mit den Wandelementen sein.

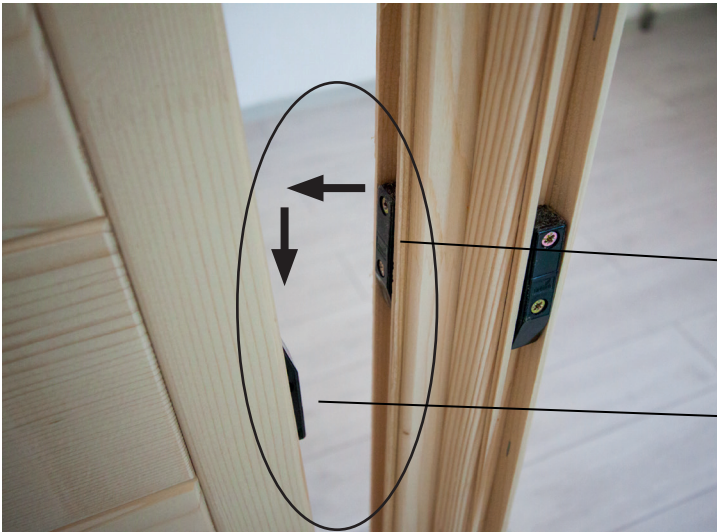

Multiclip



DE



Montage Wandelemente

Das Elektroelement hat Bohrungen zum Verlegen der Kabel. Position siehe Grundrisspläne auf Seite 31 und Seite 32.



Elektroelement

Verschrauben der Wandelemente

Überprüfen Sie die rechten Winkel, bevor Sie die Wandelemente verschrauben. Beachten Sie den Tipp auf Seite 4.



DE

Bohrer 3 mm, 4 Stk. Schrauben 4 x 70 mm

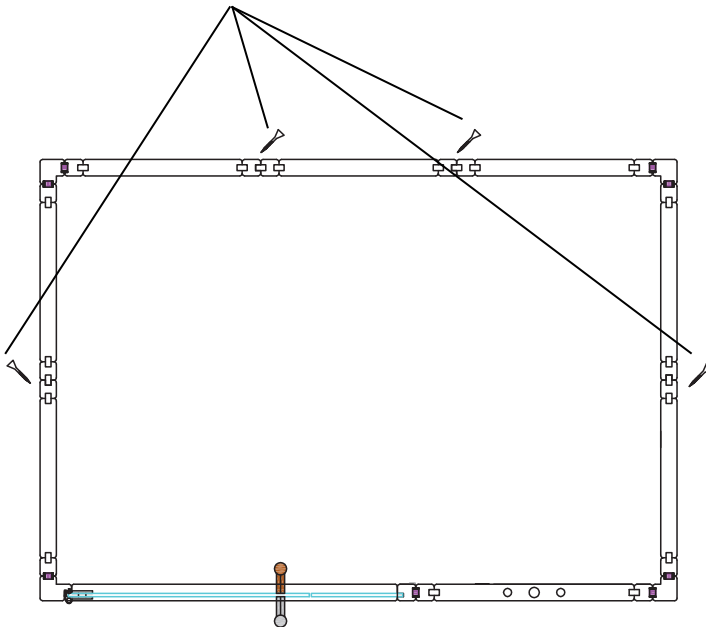

Ecksteher und Steher für Glas



Glaselement



Element oberhalb der Tür

Das Element für Grundriss „rechts“ auswählen

DE





Bohrer 3 mm, 2 Stk. Schrauben 4 x 70 mm



2.3. Montage Dach Dachauflageleisten



DE

Bohrer 3 mm, 12 Stk. Schrauben 4 x 70 mm



Dachelemente

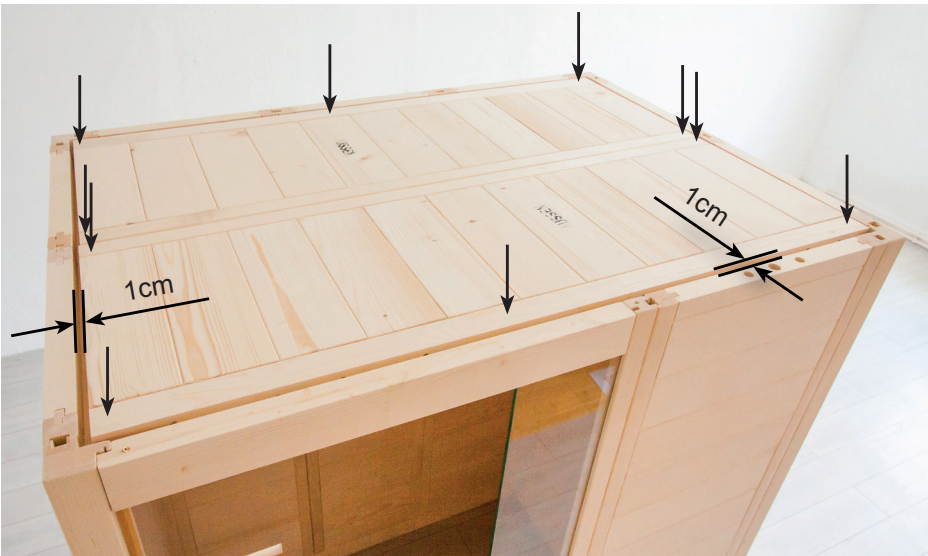

Bohrer 3 mm, 10 Stk. Schrauben 4 x 70 mm

2.4. Montage Lüftungsschieber



Bohrer 3 mm, 4 Stk. Schrauben 3 x 40 mm

2.5. Montage Inneneinrichtung

Bankauflageleisten

Bohrer 3 mm, 3 Stk. Schrauben 5 x 70 mm



2 Stk. Schrauben 4 x 60 mm

Bohrer 3 mm, 3 Stk. Schrauben 5 x 70 mm



Schrauben 4 x 60 mm

Banksichtblende



DE

4 Stk. Schrauben 4 x 60 mm

Bank



Fußauftritt



6 Stk. Schrauben 4 x 70 mm



DE

4 Stk. Schrauben 3,5 x 35 mm



Rückenlehne



Bohrer 3 mm, 3 Stk. Schrauben 3 x 40 mm



2.6. Montage Zubehör Saunaleuchte



Leuchtmittel einsetzen
(nicht im Lieferumfang enthalten)



Bohrer 3 mm, 2 Stk. Schrauben



4 Stk. Schrauben 3 x 40 mm

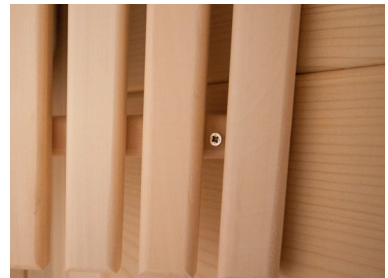

Ofenschutzgitter



Bohren Sie vor der Montage des Ofenschutzgitters den Auslass für das Ofenkabel im Elektroelement.

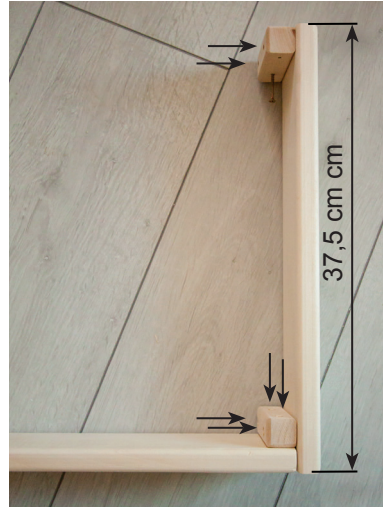

12 Stk. Schrauben 3 x 40 mm



Ofenschutzgitter individuell kürzbar

2.7. Montage Glastür



Die untere Bohrung des Türgriffs ist in 92,4 cm Höhe.
Die Ausrichtung der Beschläge wird durch die Justierung / Drehung der beiden Kunststoffeinlagen vorgenommen.

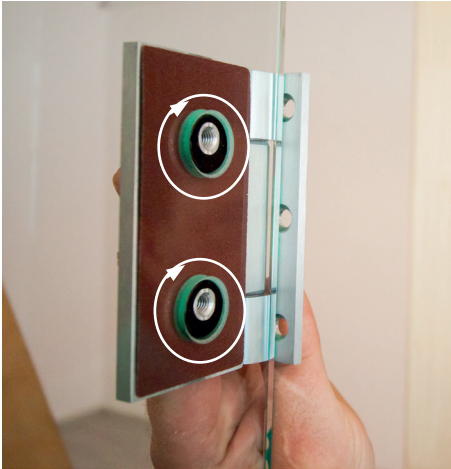

DE

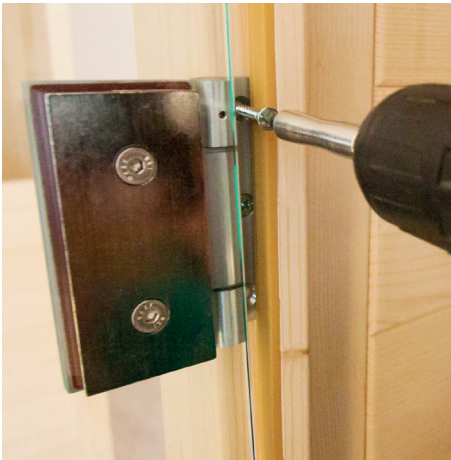

Türgriff und Überschubblech

Die Türgriffe werden von innen miteinander verschraubt.

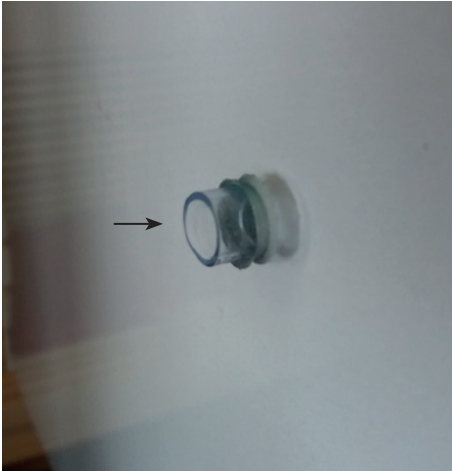

Silikonring in Bohrungen einlegen



Kunststoff-Beilagscheiben bei Niro-Griff beilegen



2.8. Montage Dachkranz



Montieren Sie den Dachkranz erst nachdem Sie die Kabel zum Saunaofen und zur Saunasteuerung eingezogen haben. Möglicherweise muss die Leiste beim Elektroelement ausgeschnitten werden.



Bohrer 3 mm, 9 Stk. Schrauben 3 x 40 mm

2.9. Montage Dachabdeckleiste



Montieren Sie die Dachabdeckleiste erst nachdem Sie die Kabel zum Saunaofen und zur Saunasteuerung eingezogen haben. Möglicherweise muss die Leiste beim Elektroelement ausgeschnitten werden.



12 Stk. Schrauben 3 x 40 mm

3. Grundriss

3.1. Grundriss „rechts“

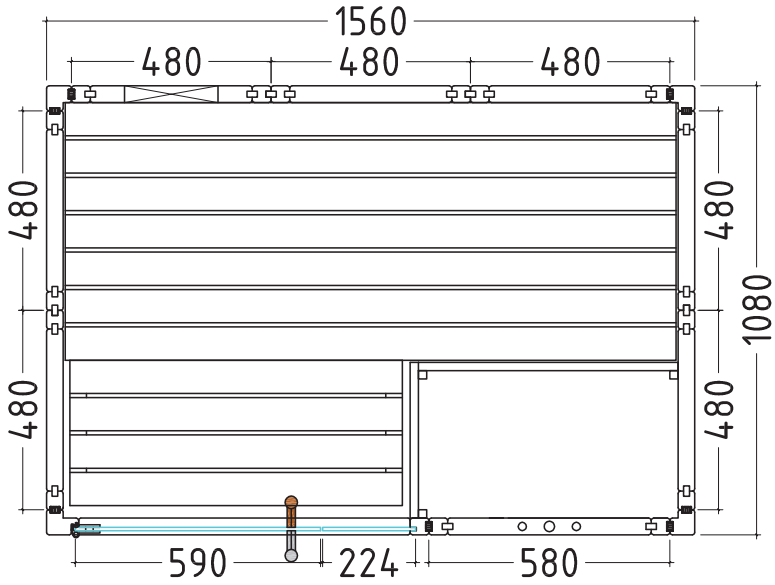

DE

3.2. Grundriss „links“

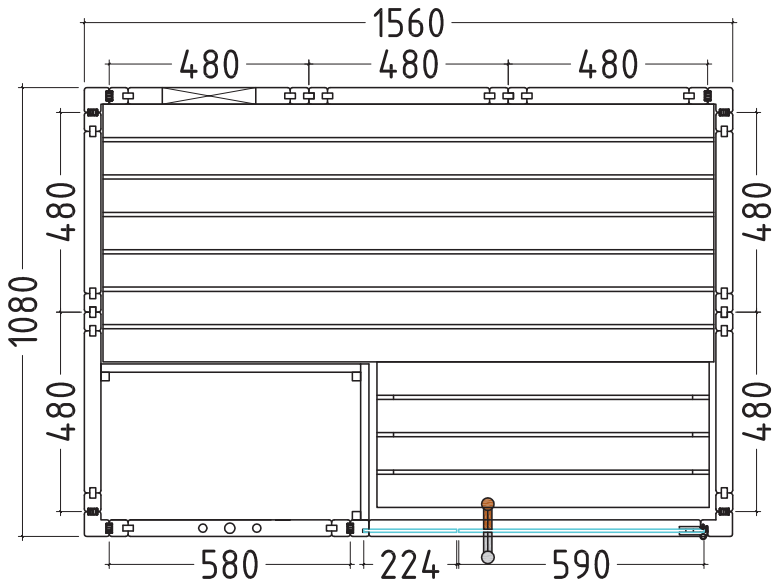

3.3. Änderungen bei Montage Grundriss „links“

Für die Montage von Ecksteher und Steher für das Glas (Seite 14)

Entfernen Sie die Muldclips vom Ecksteher und dem Steher für Glas.
Verwenden Sie die beiliegende Schablone für die neue Positionierung der Muldclips.



Element oberhalb der Tür (Seite 15)

Das Element für Grundriss „links“ auswählen





sentiotec GmbH | Division of Harvia Group | Oberregauer Straße 48, A-4844 Regau
T +43 (0) 7672/277 20-567 | F -801 | info@sentiotec.com | www.sentiotec.com

Solid wood sauna

ALASKA

MINI

160 x 110 x 204 cm

INSTRUCTIONS FOR INSTALLATION AND USE
English

EN



Table of Contents

1. Preparing for installation	3
1.1. Tools required	4
1.2. Maintenance and cleaning	5
1.3. Disposal	5
1.4. Warranty	5
1.5. ALASKA MINI parts list	7
2. Cabin installation	9
2.1. Base frame installation	9
2.2. Wall element installation	10
2.3. Ceiling installation	17
2.4. Ventilation slit installation	19
2.5. Installing interior fittings	19
2.6. Installing accessories	25
2.7. Installing glass door	27
2.8. Installing roof trim	29
2.9. Installing ceiling cover slat	30
3. Floor plan	31
3.1. Right floor plan	31
3.2. Left floor plan	32
3.3. Changes to the left floor plan installation	33

1. Preparing for installation

Read these installation instructions carefully and keep them within reach when using the sauna, so that you can look up product information at any time.



These installation instructions can also be found in the downloads section of our website: www.sentiotec.com/downloads.

Important note:

- Before you begin work, check the parts list to ensure that all the individual parts have been delivered. If you discover any missing parts, notify your dealer within 14 days of receiving the sauna cabin.
- The room that the sauna is installed in must be dry and ensure an appropriate amount of air circulation.
- The floor must be level and even, preferably a stone or tiled floor.
- A minimum room height of 230 cm is required for the cabin installation work.
- A distance of at least 5 cm from the wall must be maintained.
- The inside of the wooden parts used must not be treated with any impregnating material.
- You need an assistant for the installation.
- Wood is a natural product that can swell, shrink or warp, despite good storage. For this reason, some force may be necessary during the installation.
- All screw fittings must be pre-drilled.

Attention!

The electrical connection may only be performed by a qualified electrician or similarly trained person.

1.1. Tools required

- Hammer with a wooden head or a mallet
- Cordless screwdriver with bits for cross-head screws and Torx
- Roller tape measure
- Drill bits with a diameter of 3 mm, 10 mm, 20 - 30 mm (for sauna heater power cable)
- Spirit level
- 1.5 mm hexagonal socket wrench
- Utility knife
- Ladder
- Backsaw



This symbol indicates tips and useful information



Pre-drill



Cut to real measurement with backsaw



Check the right angle:

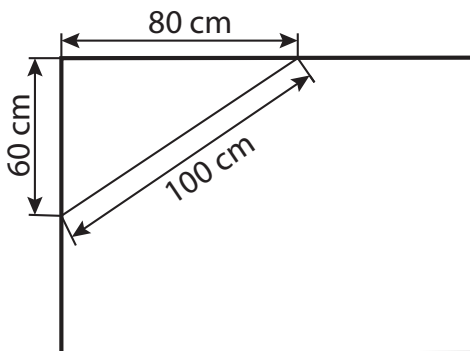

1.2. Maintenance and cleaning

- The sauna should be cleaned with a damp cloth. Only use warm water – no cleaning products.
- We recommend heating the cabin once a month if the sauna is not used for a long time.

1.3. Disposal



- Please dispose of packaging materials in accordance with the applicable disposal regulations.
- Used appliances contain reusable materials as well as hazardous substances. Therefore, do not dispose of your used appliance with household waste, but rather do so in accordance with the locally applicable regulations.

1.4. Warranty

We provide a five-year warranty on all of our solid wood and element cabins of the line sentiotec sauna and sentiotec infra for private usage. For commercial usage, the warranty is two years. For cabins of the hotline series, the warranty is two years.

Requirement for this warranty:

- The corresponding invoice is presented,
- a detailed description of the defect is enclosed,
- the cabins were installed in accordance with the sentiotec installation and operating instructions,
- the warranty claim is received by sentiotec within the warranty period.

Excluded from the warranty are:

- Deficiencies or damage that is caused by non-intended use
- Cabins that were modified without the explicit approval of the manufacturer
- Pitch pockets
- Pitch leaking out
- Damage and discolouration of the wood due to inadequate ventilation or a non-intended installation site
- Natural changes in the wood such as discolouration, crack formation, shrinkage, swelling or similar changes due to the natural properties of the wood

Pitch pockets are not grounds for return, since they can always appear in spruce wood and the depth at which they lie cannot be detected during the sorting out process. If these are just under the surface, heat can cause them to soften and “bleed”. Remove leaking pitch with a rag soaked in acetone. If only droplets of pitch occur, allow these to harden and then carefully scrape them off with a knife.

The warranty period starts from the date of invoice of the cabin manufacturer. A requirement is the presentation of the original invoice. If no original invoice is available, the month of manufacture, noted on the nameplate of the product, is used as the basis for the start of the warranty period. The warranty period is neither extended nor renewed by warranty services.

The five-year warranty is an addition to the terms and conditions of sentiotec GmbH.

1.5. ALASKA MINI parts list

No. of items	Name	Dimensions
Base frame		
1	Base frame	156 x 9 x 4 cm
1	Base frame	108 x 9 x 4 cm
1	Base frame	102 x 9 x 4 cm
1	Base frame	64 x 9 x 4 cm
Wall elements		
1	A/B ventilation element with Multiclip	193 x 48 x 4 cm
1	A/B wall element	193 x 48 x 4 cm
1	A/B wall element with Multiclip	193 x 48 x 4 cm
4	A/A wall elements with Multiclip	193 x 48 x 4 cm
1	A/A electrical element with Multiclip	193 x 58 x 4 cm
1	Element above door, floor plan (right)	81.5 x 10.1 x 4 cm
1	Element above door, floor plan (left)	81.5 x 10.1 x 4 cm
Ceiling elements		
2	Ceiling elements	146 x 49 x 4 cm
Corner posts		
3	90° corner posts with Multiclip	193 x 6 x 6 cm
1	Corner post with front hinge for glass door with Multiclip	202 x 6 x 7.5 cm
1	Post for glass element, 8 mm groove	202 x 4.5 x 4 cm
Support slats		
2	Roof support slats	140 x 4 x 4 cm
2	Roof support slats	100 x 4 x 4 cm
2	Roof cover slats	144 x 1.2 x 4 cm
2	Roof cover slats	104 x 1.2 x 4 cm
2	Bench support slats	58 x 4 x 4 cm
2	Mounting slats for bench screen	26 x 4 x 4 cm

No. of items	Name	Dimensions
Interior fittings		
1	Bench	147 x 62 x 9 cm
1	Foot step panel	80 x 35 x 9 cm
2	Foot step feet	43 x 33 x 4 cm
2	Foot step struts, 2 x 45° diagonal	49.5 x 8 x 2 cm
1	Backrests	138 x 26 x 4 cm
1	Bench screen	147 x 35 x 4 cm
1	Heater protection grille – lime wood	62.5 x 8 x 2 cm
1	Heater protection grille – lime wood	37.5 x 8 x 2 cm
3	Mounting slats for heater protection grille – spruce	7 x 2.5 x 2.5 cm
1	Headrest	43 x 25 x 7 cm
1	Lamp protection grille	38 x 32 x 4 cm
1	Ventilation slit	52 x 14 x 1.5 cm
Glass elements		
1	Glass door	191.5 x 59 x 0.8 cm
1	Glass element	194.5 x 22.4 x 0.8 cm
Roof rim slats		
1	Roof rim slat	160 x 6 x 4 cm
2	Roof rim slats	115 x 6 x 4 cm
Accessories		
1	U aluminium profile	21.1 x 1.2 x 1.5 cm
1	Door handle set wood/stainless steel	
1	2 door hinges 8653-02	
1	Door magnet, sleeve plate	
1	Sauna lamp	
1	Template for Multiclip installation	
1	3 Silicon cables: 5 x 2.5 mm ²	
1	3 Silicon cables: 3 x 1.5 mm ²	
1	Installation material set	
1	Installation instructions	

2. Cabin installation

The cabin can have a right or left set up, please note the corresponding floor plans on Page 31 and Page 32.

2.1. Base frame installation



2.2. Wall element installation

The corner posts are connected to the wall elements using Multiclips. The other wall elements are connected by tongue and groove and are screwed together.



A always refers to the visible side. This is labelled on the top side of the wall elements.

Attention!

The installation subsequently described is for the right floor plan. For changes affecting installation for the left floor plan see Page 33.

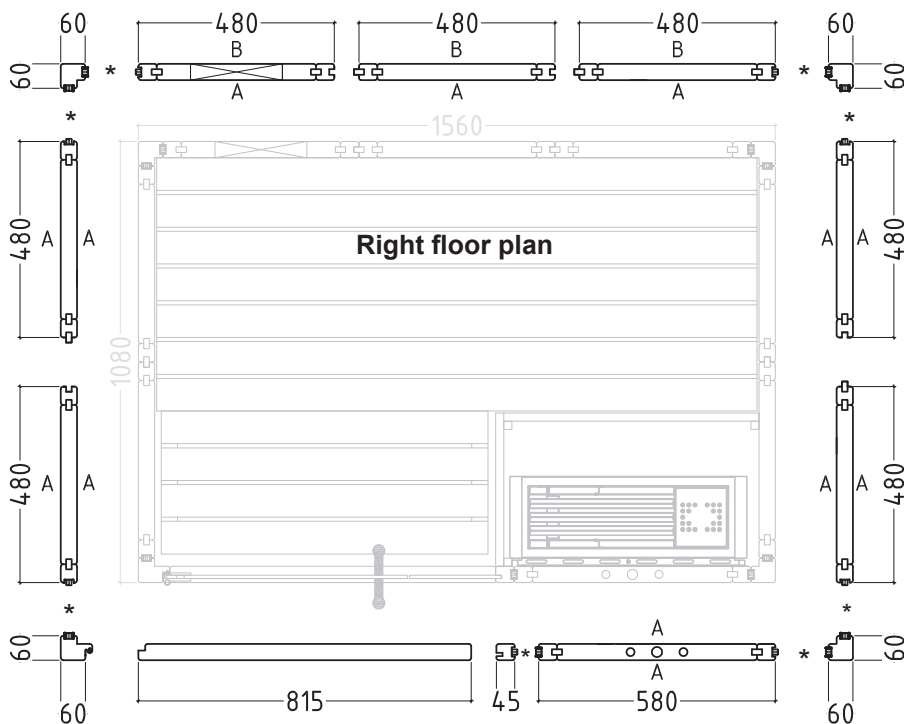

* Multiclips

Installing corner posts with wall elements

 Pre-assemble the wall elements with the corner posts on the floor and then place these posts on the base frame.

Insert the corner post on the wall elements, moving it downwards. When doing this, ensure that the Multiclips are correctly aligned (see below). The corner post must be flush with the wall elements.

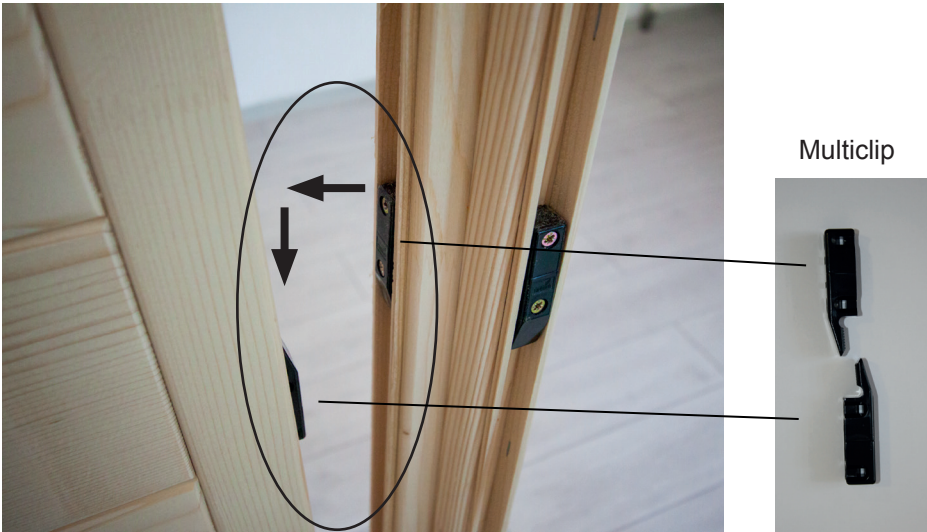

Installing wall elements



The electrical element has drill holes for laying cables. For the position, see floor plans on Page 31 and Page 32.



Electrical element

Screwing wall elements together



Check the right angle before screwing the wall elements together.
Observe the tip on page 4.



EN

3 mm drill bit, 4 screws 4 x 70 mm

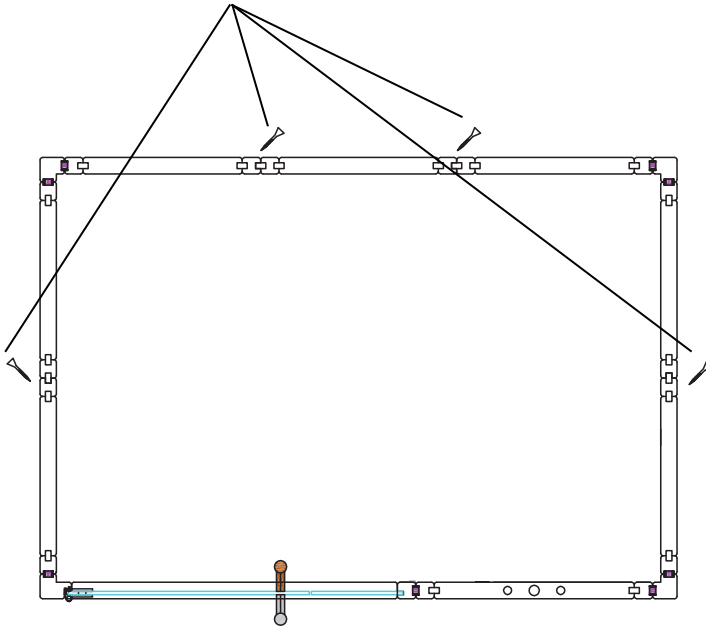

Corner post and post for glass



Glass element



Element above the door

Select the element for the right floor plan





3 mm drill bit, 2 screws 4 x 70 mm



2.3. Ceiling installation

Roof support slats



EN

3 mm drill bit, 12 screws 4 x 70 mm



Ceiling elements

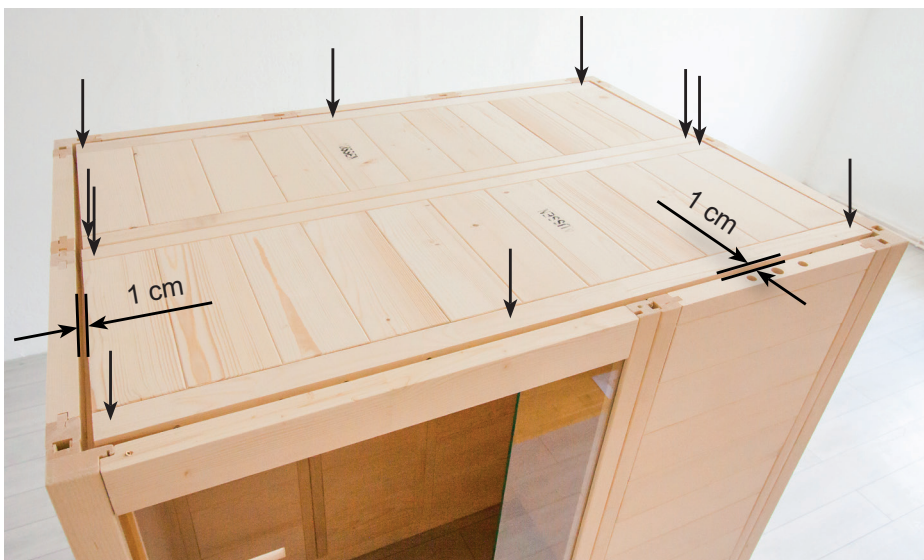

3 mm drill bit, 10 screws 4 x 70 mm

2.4. Ventilation slit installation



3 mm drill bit, 4 screws 3 x 40 mm

EN

2.5. Installing interior fittings

Bench support slats

3 mm drill bit, 3 screws 5 x 70 mm



2 screws 4 x 60 mm

3 mm drill bit, 3 screws 5 x 70 mm



Screws 4 x 60 mm

Bench screen



4 screws 4 x 60 mm

Bench



Foot step



6 screws 4 x 70 mm



4 screws 3.5 x 35 mm



Backrests



3 mm drill bit, 3 screws 3 x 40 mm



2.6. Installing accessories

Sauna lamp



Insert lamp
(not included in the scope of delivery)



3 mm drill bit, 2 screws

EN



4 screws 3 x 40 mm



Heater protection grille



Before installing the heater protection grille, drill the outlet for the heater cable in the electrical element.

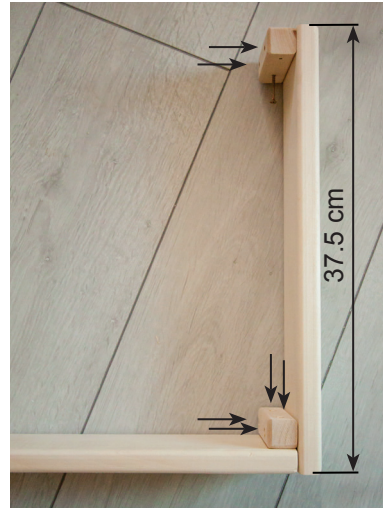

12 screws 3 x 40 mm



Heater protection grille can be shortened to length

2.7. Installing glass door



The bottom drill hole of the door handle is 92.4 cm high.
The alignment of the fittings is achieved by adjusting / rotating both plastic inserts.

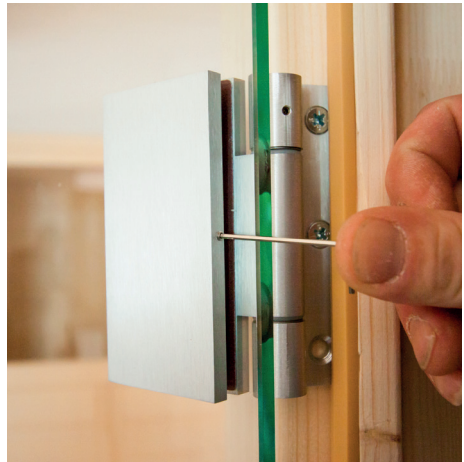
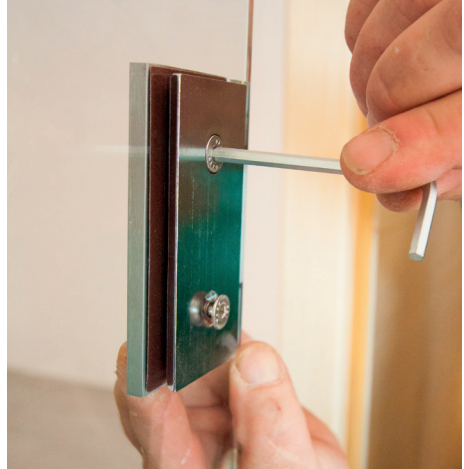
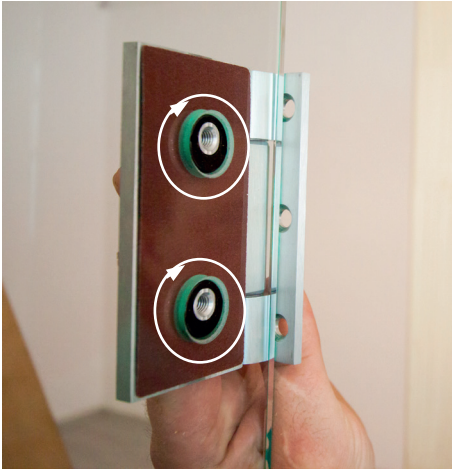

Door handle and sleeve plate

The door handles are screwed together from the inside.

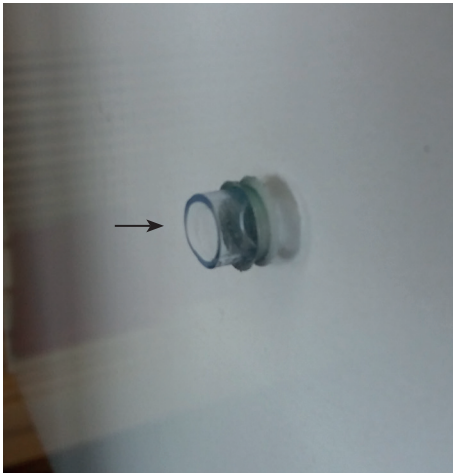

Insert silicone ring in the drill holes



Attach plastic washers on the stainless steel handle



2.8. Installing roof trim



Install the roof trim only after you have inserted the cable to the sauna heater and to the sauna control unit. The slat on the electrical element may possibly have to be cropped.



EN



3 mm drill bit, 9 screws 3 x 40 mm

2.9. Installing ceiling cover slat



Install the ceiling cover slat only after you have inserted the cable to the sauna heater and to the sauna control unit. The slat on the electrical element may possibly have to be cropped.



12 screws 3 x 40 mm

3. Floor plan

3.1. Right floor plan

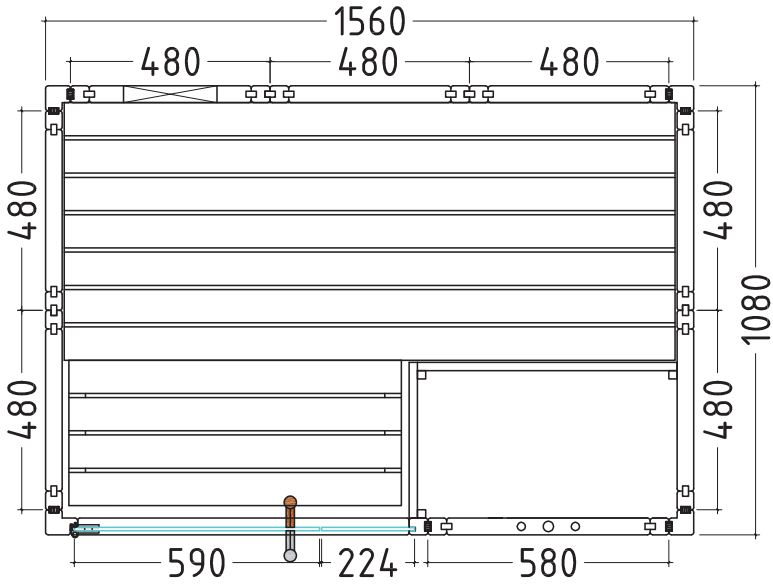

3.2. Left floor plan

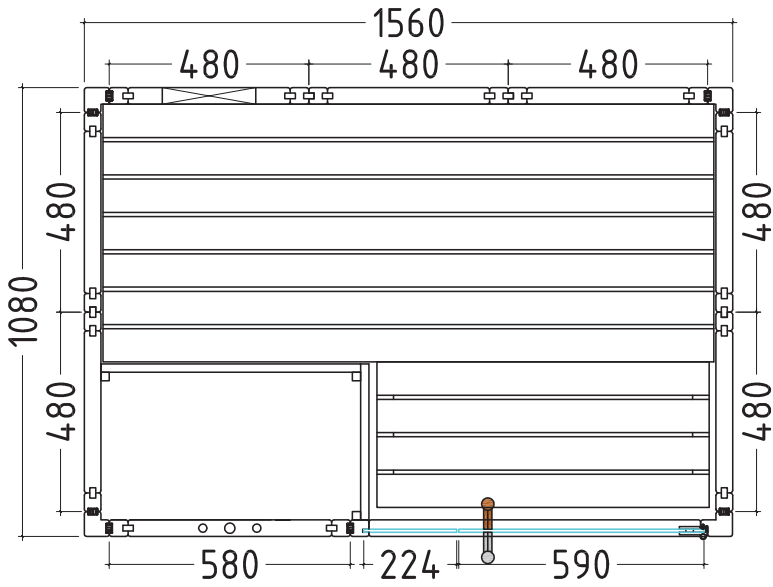

3.3. Changes to the left floor plan installation

For installing corner posts and posts for the glass (page 14)

Remove the Multiclips from the corner posts and the post for the glass.
Use the supplied template for the new positioning of the Multiclips.



EN

Element above the door (page 15)

Select the element for the left floor plan





sentiotec GmbH | Division of Harvia Group | Oberregauer Straße 48, A-4844 Regau
Phone +43 (0) 7672/277 20-567 | Fax -801 | info@sentiotec.com | www.sentiotec.com

Sauna en bois massif

ALASKA

MINI

160 x 110 x 204 cm

INSTRUCTIONS DE MONTAGE ET MODE D'EMPLOI
Français



FR

Table des matières

1. Préparation du montage	3
1.1. Outils requis	4
1.2. Entretien et nettoyage	5
1.3. Élimination	5
1.4. Garantie	5
1.5. Nomenclature ALASKA MINI	7
2. Montage de la cabine	9
2.1. Montage du cadre de plancher	9
2.2. Montage des éléments muraux	10
2.3. Montage du toit	17
2.4. Montage du registre d'aération	19
2.5. Montage de l'équipement intérieur	19
2.6. Montage des accessoires	25
2.7. Montage de la porte en verre	27
2.8. Montage de la couronne	29
2.9. Montage de la baguette couvre-joint	30
3. Plan	31
3.1. Plan « à droite »	31
3.2. Plan « à gauche »	32
3.3. Modifications lors du montage selon le plan « à gauche »	33

1. Préparation du montage

Lisez attentivement les présentes instructions de montage et gardez-les à proximité de l'appareil. Vous pouvez ainsi accéder à tout moment aux informations sur le produit.



Vous trouverez ces instructions de montage également dans la rubrique de téléchargement de notre site Internet www.sentiotec.com/downloads.

Remarques importantes :

- Avant de commencer les travaux, vérifiez au moyen de la nomenclature si toutes les pièces ont bien été livrées. S'il devait s'avérer que des pièces manquent, informez votre revendeur dans les 14 jours suivant la réception de la cabine.
- La pièce dans laquelle la cabine de sauna sera montée doit être sèche et disposer d'une circulation d'air suffisante.
- Le sol doit être horizontal et lisse, de préférence en pierre ou en carrelage.
- Pour les travaux de montage de la cabine, la pièce doit avoir une hauteur de 230 cm minimum.
- Une distance d'au moins 5 cm par rapport au mur doit être respectée.
- Les pièces en bois prévues pour l'intérieur ne doivent pas être traitées avec un agent d'imprégnation.
- Une deuxième personne doit être disponible pour vous aider lors du montage.
- Malgré un stockage correct, le bois est un produit naturel qui peut gonfler, se contracter ou se déformer. C'est pourquoi il peut arriver que vous ayez à appliquer de la force lors du montage.
- Tous les raccords vissés doivent être pré-perçés.

Attention !

Seul un électricien spécialisé ou une personne ayant une qualification similaire est habilité à procéder au raccordement électrique.

1.1. Outils requis

- Marteau et cale en bois ou maillet en caoutchouc
- Visseuse électrique avec bits pour vis en croix et Torx
- Ruban de mesure
- Foret de 3 mm de diamètre, 10 mm, 20-30 mm (pour câble électrique poêle de sauna)
- Niveau à bulle
- Clé Allen 1,5 mm
- Couteau universel
- Échelle
- Scie fine



Ce symbole désigne les conseils et indications utiles.

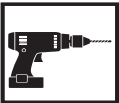

Pré-perçage



Sciage à la bonne longueur avec une scie fine



Contrôle de l'angle droit :

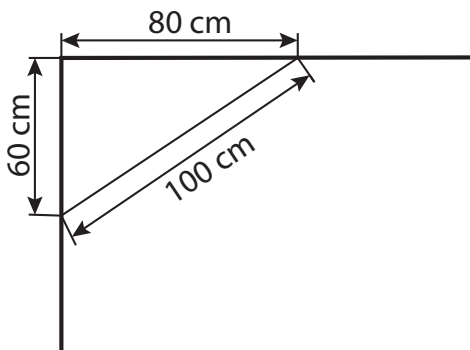

1.2. Entretien et nettoyage

- Le sauna doit être nettoyé avec un chiffon humide. N'utilisez que de l'eau chaude, pas de détergent.
- Si le sauna n'est pas utilisé pendant une période prolongée, nous recommandons de chauffer la cabine une fois par mois.

1.3. Élimination



- Éliminez les matériaux d'emballage conformément aux directives en vigueur relatives à l'élimination.
- Les appareils usagés contiennent des matériaux recyclables, mais aussi des substances toxiques. Par conséquent, ne jetez en aucun cas votre appareil usagé avec les déchets ménagers. Éliminez-le conformément aux directives locales en vigueur.

1.4. Garantie

Nous offrons sur toutes nos cabines massives et à base d'éléments de la gamme sentiotec sauna cinq ans de garantie pour les particuliers. La garantie est de deux ans en cas d'usage professionnel. La garantie est de deux ans pour les cabines de la gamme hotline.

FR

Prérequis pour l'application de cette garantie :

- présenter la facture correspondante,
- accompagner la demande d'une description détaillée du défaut,
- les cabines doivent être montées conformément aux instructions de montage et au mode d'emploi,
- la garantie s'applique pendant la période de garantie auprès de sentiotec.

La garantie ne couvre pas :

- les défauts ou les dommages résultant d'une utilisation non conforme à sa destination
- Cabines modifiées sans l'accord explicite du fabricant
- Poches de résine
- Écoulement de résine
- Défauts et décolorations du bois résultant d'une ventilation insuffisante ou d'un emplacement d'installation non conforme à sa destination
- Modifications naturelles du bois telles que décoloration, fissures, retrait, gonflement ou autres altérations résultant des propriétés naturelles du bois

Les poches de résines ne constituent pas un motif de réclamation, en raison de leur présence régulière dans le bois d'épicéa et de l'impossibilité de déterminer leur profondeur lors de la sélection du bois. Si elles se trouvent juste sous la surface, elles éclatent et s'écoulent en raison de la chaleur. Retirez la résine écoulée à l'aide d'un chiffon imbibé d'acétone. Si vous constatez uniquement des gouttes de résine, attendez qu'elles aient durci puis découpez-les avec précaution à l'aide d'un couteau.

La période de garantie prend effet à compter de l'établissement de la facture par le fabricant de la cabine. Elle est soumise à la présentation de la facture originale. En l'absence de facture originale, le mois de fabrication figurant sur la plaque signalétique du produit détermine le début de la période de garantie. La durée de la garantie n'est pas prolongée ni renouvelée par les prestations de garantie.

La garantie de cinq ans est un complément des Conditions générales de vente de la société sentiotec GmbH.

1.5. Nomenclature ALASKA MINI

Nb	Désignation	Dimensions
Cadre de plancher		
1	Cadre de plancher	156 x 9 x 4 cm
1	Cadre de plancher	108 x 9 x 4 cm
1	Cadre de plancher	102 x 9 x 4 cm
1	Cadre de plancher	64 x 9 x 4 cm
Éléments muraux		
1	Élément de ventilation A/B avec multclip	193 x 48 x 4 cm
1	Élément mural A/B	193 x 48 x 4 cm
1	Élément mural A/B avec multclip	193 x 48 x 4 cm
4	Éléments muraux A/A avec multclip	193 x 48 x 4 cm
1	Éléments électriques A/A avec multclip	193 x 58 x 4 cm
1	Élément au-dessus de la porte, plan « à droite »	81,5 x 10,1 x 4 cm
1	Élément au-dessus de la porte, plan « à gauche »	81,5 x 10,1 x 4 cm
Éléments du toit		
2	Éléments du toit	146 x 49 x 4 cm
Montant d'angle		
3	Montant d'angle 90° avec multclip	193 x 6 x 6 cm
1	Montant d'angle avec sertissage à l'avant pour porte en verre avec multclip	202 x 6 x 7,5 cm
1	Montant pour élément en verre rainure 8 mm	202 x 4,5 x 4 cm
Baguettes d'appui		
2	Baguettes d'appui de toit	140 x 4 x 4 cm
2	Baguettes d'appui de toit	100 x 4 x 4 cm
2	Baguettes couvre-joints de toit	144 x 1,2 x 4 cm
2	Baguettes couvre-joints de toit	104 x 1,2 x 4 cm
2	Baguettes d'appui de banc	58 x 4 x 4 cm
2	Baguettes de montage pour écran de banc	26 x 4 x 4 cm

Nb	Désignation	Dimensions
Équipement intérieur		
1	Banc	147 x 62 x 9 cm
1	Plaque de marche pied	80 x 35 x 9 cm
2	Marchepied pieds	43 x 33 x 4 cm
2	Marchepied étais, inclinaison 2 x 45°	49,5 x 8 x 2 cm
1	Dossier	138 x 26 x 4 cm
1	Écran de banc	147 x 35 x 4 cm
1	Grille de protection du poêle – tilleul	62,5 x 8 x 2 cm
1	Grille de protection du poêle – tilleul	37,5 x 8 x 2 cm
3	Baguettes de montage pour grille de protection du poêle – pin	7 x 2,5 x 2,5 cm
1	Appui-tête	43 x 25 x 7 cm
1	Grille de protection de lampe	38 x 32 x 4 cm
1	Registres d'aération	52 x 14 x 1,5 cm
Éléments en verre		
1	Porte en verre	191,5 x 59 x 0,8 cm
1	Élément en verre	194,5 x 22,4 x 0,8 cm
Baguettes de la couronne		
1	Baguette de la couronne	160 x 6 x 4 cm
2	Baguettes de la couronne	115 x 6 x 4 cm
Accessoires		
1	Profilé en U alu	21,1 x 1,2 x 1,5 cm
1	Kit poignée bois/inox	
1	2 charnières 8653-02	
1	Aimant de porte, tôle extérieure	
1	Éclairage de sauna	
1	Gabarit pour montage multiclip	
1	Câble silicone 3 mc 5 x 2,5 mm ²	
1	Câble silicone 3 mc 3 x 1,5 mm ²	
1	Kit de matériel de montage	
1	Instructions de montage	

2. Montage de la cabine

La cabine peut être montée « à droite » ou « à gauche ». Référez-vous aux plans Page 31 et Page 32.

2.1. Montage du cadre de plancher

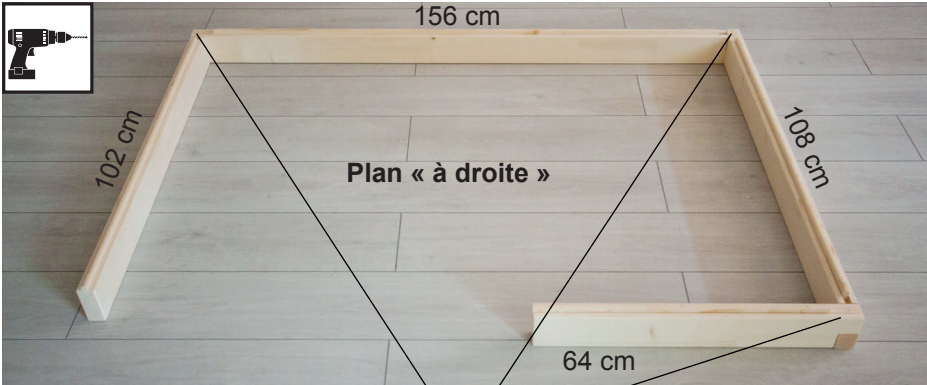

2.2. Montage des éléments muraux

Les montants d'angle sont fixés aux éléments muraux au moyen des « multiclips ». Les autres éléments muraux sont reliés par des rainures et des languettes et sont vissés les uns aux autres.



A désigne toujours le côté apparent qui est indiqué sur la face supérieure des éléments muraux.

Attention !

Ci-après, le montage du plan « à droite » est décrit.

Pour toutes modifications relatives au montage selon le plan « à gauche », voir Page 33.

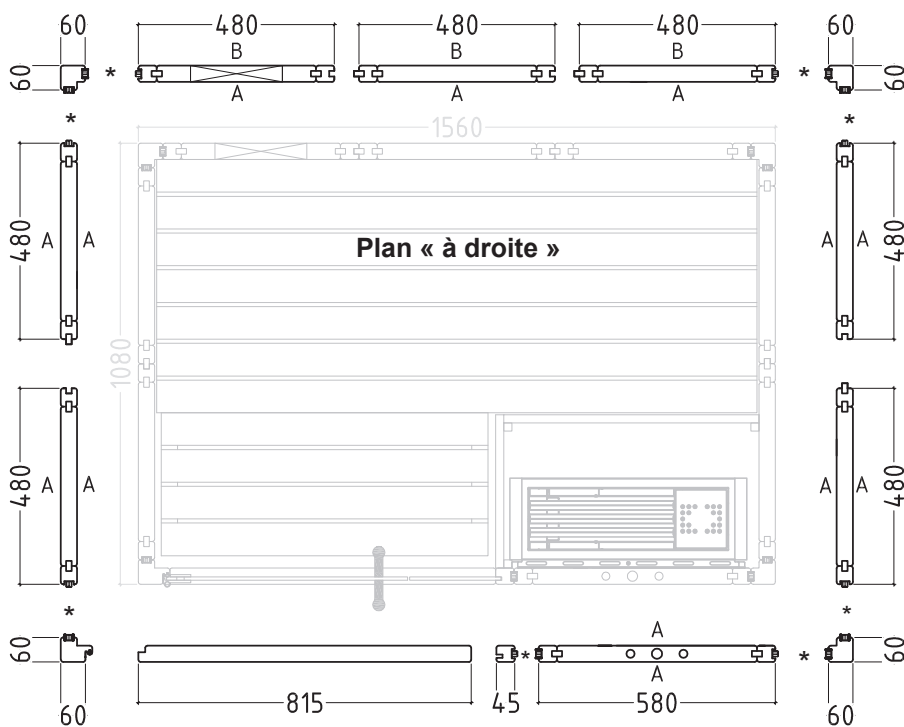

* Multiclips

Montage des montants d'angle sur les éléments muraux

Pré-montez les éléments muraux et les montants d'angle au sol, puis placez ces angles sur le cadre de plancher.

Placez le montant d'angle par le haut vers le bas sur les éléments muraux. Assurez-vous que l'orientation des « multiclips » est correcte (voir ci-dessous). Le montant d'angle doit affleurer les éléments muraux.

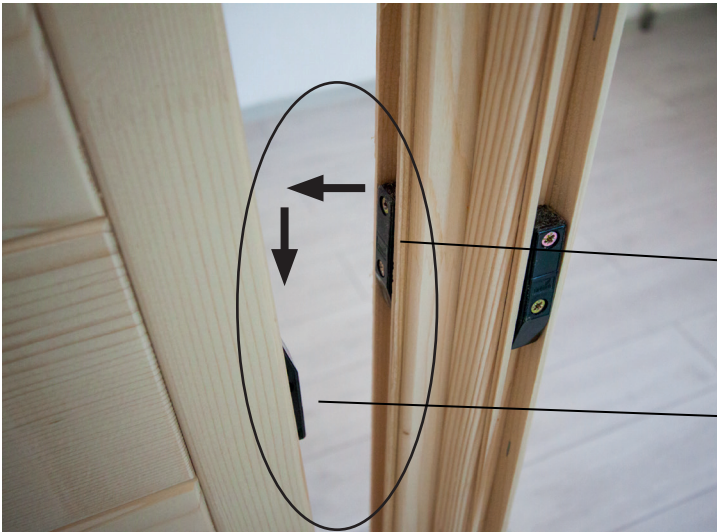

Multiclip



FR



Montage des éléments muraux

Des trous sont prévus sur l'élément électrique afin de poser le câble.
Pour la position, consultez Page 31 et Page 32.



Élément électrique

Vissage des éléments muraux



Contrôlez les angles droits avant de visser les éléments muraux. Consultez le conseil page 4.



Foret de 3 mm, 4 vis 4 x 70 mm

FR

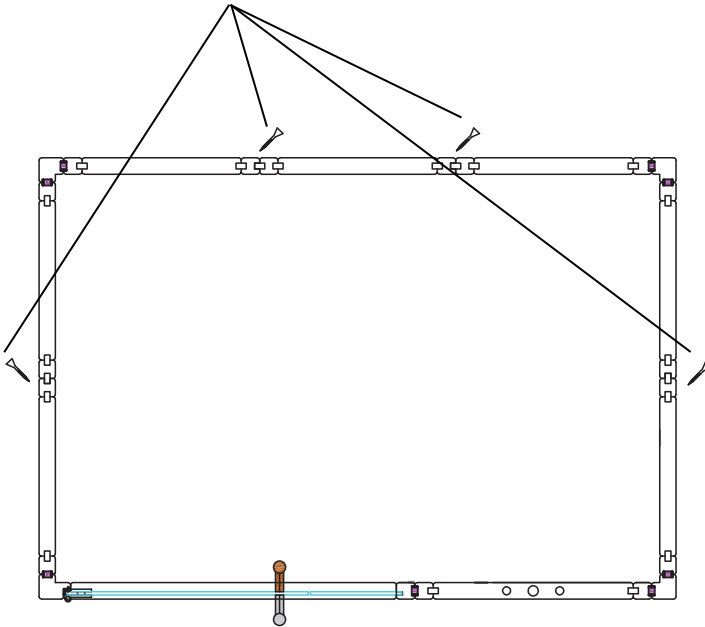

Montant d'angle et montant pour verre



Élément en verre

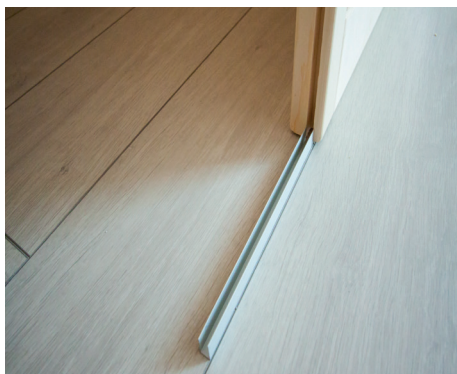

Élément au-dessus de la porte

Sélection de l'élément pour le plan « à droite »



FR



Foret de 3 mm, 2 vis 4 x 70 mm

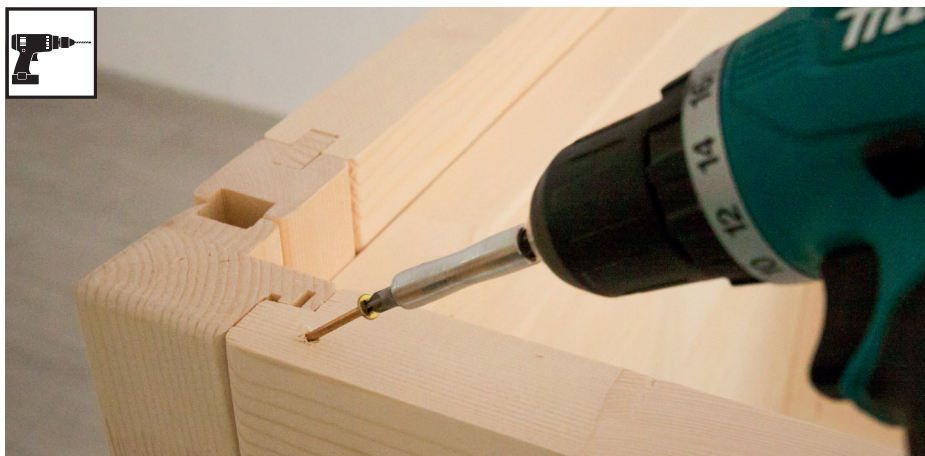

2.3. Montage du toit

Baguettes d'appui de toit



FR

Foret de 3 mm, 12 vis 4 x 70 mm



Éléments du toit

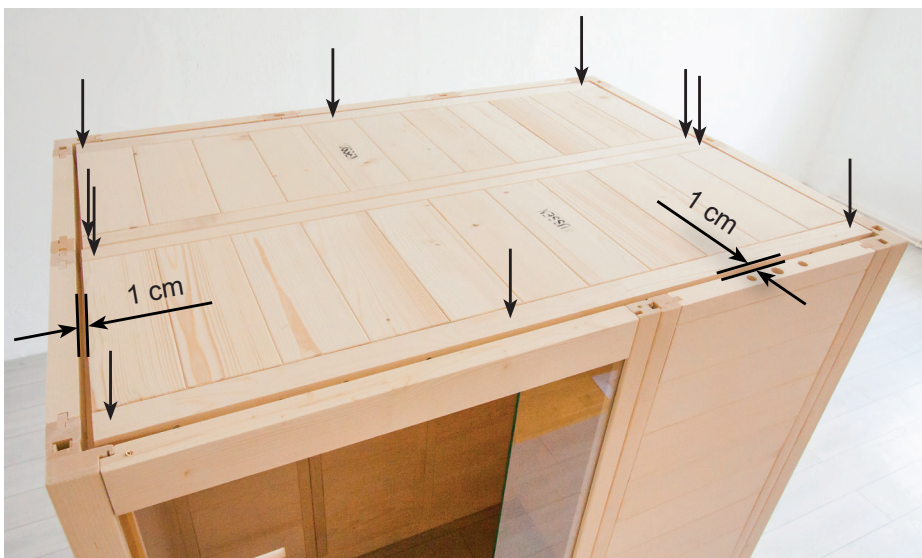

Foret de 3 mm, 10 vis 4 x 70 mm

2.4. Montage du registre d'aération



Foret de 3 mm, 4 vis 3 x 40 mm

2.5. Montage de l'équipement intérieur

Baguettes d'appui de banc

Foret de 3 mm, 3 vis 5 x 70 mm



2 vis 4 x 60 mm

Foret de 3 mm, 3 vis 5 x 70 mm



Vis 4 x 60 mm

Écran de banc



4 vis 4 x 60 mm

Banc



Marchepied



6 vis 4 x 70 mm



4 vis 3,5 x 35 mm

FR



Dossier



Foret de 3 mm, 3 vis 3 x 40 mm



2.6. Montage des accessoires

Éclairage de sauna



Mise en place des ampoules
(non compris dans la livraison)



Foret de 3 mm, 2 vis



4 vis 3 x 40 mm

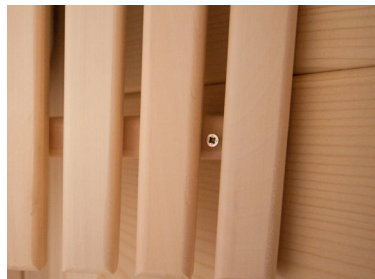

Grille de protection du poêle

Avant le montage de la grille de protection du poêle, percez la sortie pour le câble du poêle dans l'élément électrique.

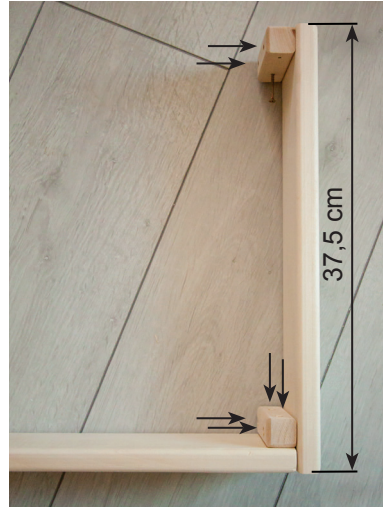

12 vis 3 x 40 mm



Grille de protection du poêle pouvant être raccourcie individuellement

2.7. Montage de la porte en verre



L'alésage inférieur de la poignée de porte se trouve à 92,4 cm de haut.
L'orientation des ferrures est effectuée en ajustant/tournant les deux armatures en plastique.

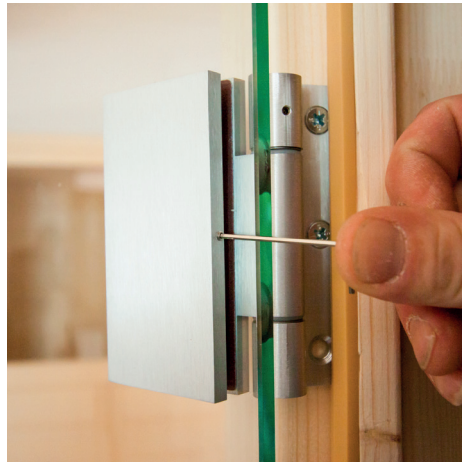
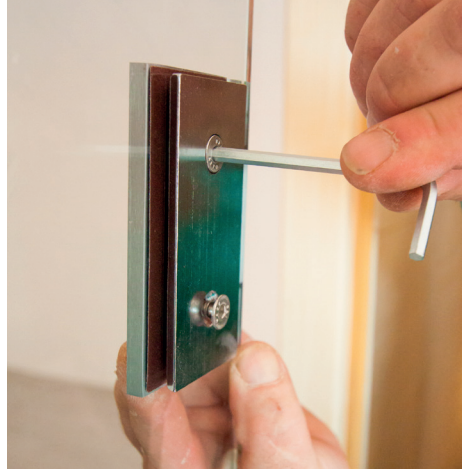
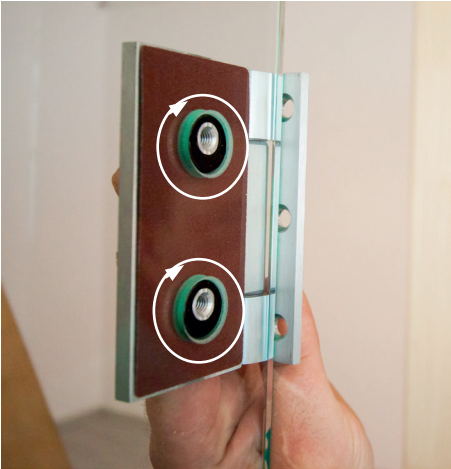

Poignée de porte et tôle extérieure

Les poignées sont vissées ensemble depuis l'intérieur.

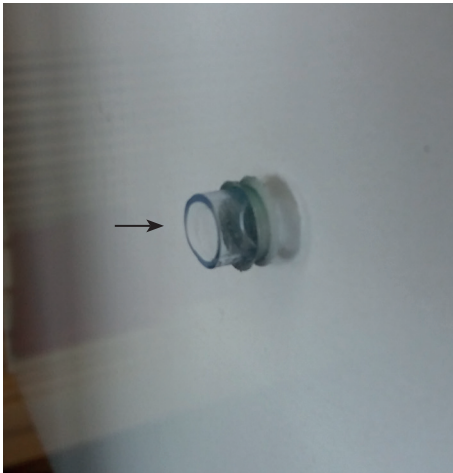

Introduction de la bague en silicone dans les alésages



Pose des rondelles de calage en plastique pour poignée inox



2.8. Montage de la couronne



Ne montez la couronne qu'après avoir inséré les câbles vers le poêle de sauna et la commande de sauna. La baguette au niveau de l'élément électrique doit éventuellement être coupée.



Foret de 3 mm, 9 vis 3 x 40 mm

2.9. Montage de la baguette couvre-joint



Ne montez la baguette couvre-joint qu'après avoir inséré les câbles vers le poêle de sauna et la commande de sauna. Avec l'élément électrique, il peut arriver que la baguette doive être coupée.



12 vis 3 x 40 mm

3. Plan

3.1. Plan « à droite »

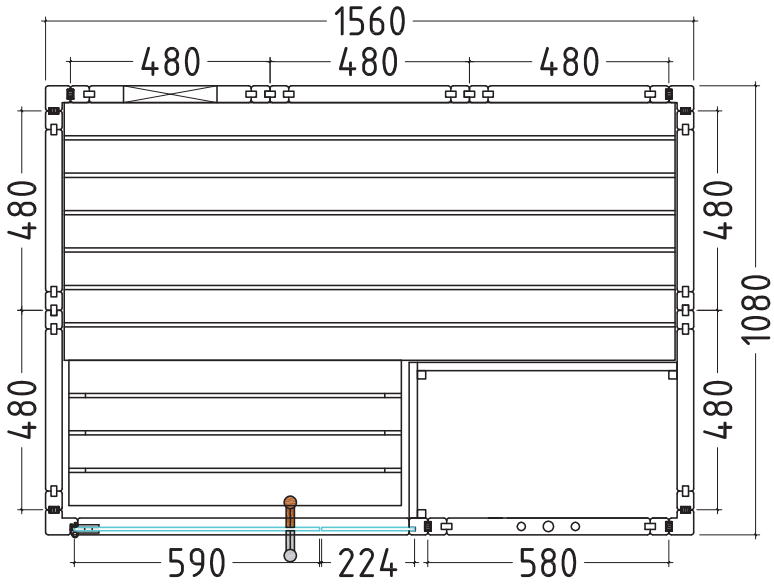

3.2. Plan « à gauche »

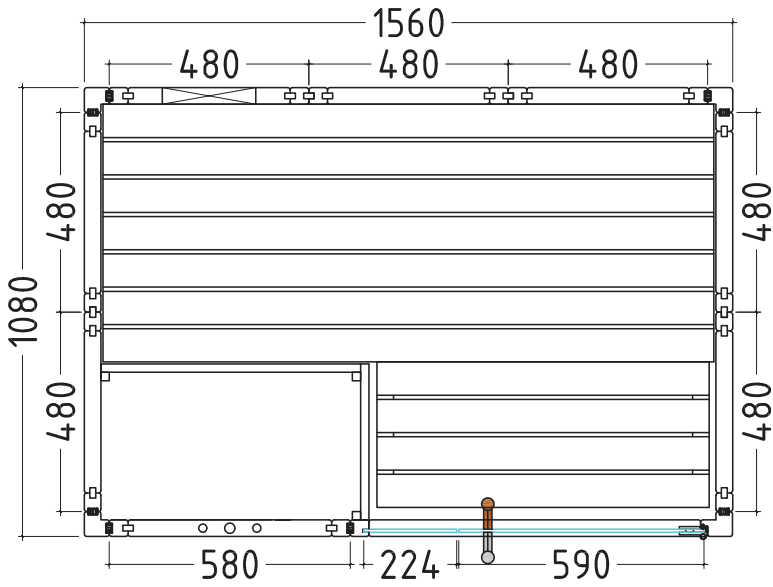

3.3. Modifications lors du montage selon le plan « à gauche »

Pour le montage de montants d'angle et de montants pour le verre (page 14)

Retirez les multiclips pour montant d'angle et montant pour le verre.

Utilisez les gabarits fournis pour le nouveau positionnement des multiclips.



FR

Élément au-dessus de la porte (page 15)

Sélection de l'élément pour le plan « à gauche »





sentiotec GmbH | Division of Harvia Group | Oberregauer Straße 48, A-4844 Regau
T +43 (0) 7672/277 20-567 | F -801 | info@sentiotec.com | www.sentiotec.com

Sauna in legno massiccio

ALASKA

MINI

160 x 110 x 204 cm

ISTRUZIONI DI MONTAGGIO E D'USO
Italiano



IT

Indice

1. Preparazione per il montaggio	3
1.1. Attrezzi necessari	4
1.2. Manutenzione e pulizia	5
1.3. Smaltimento	5
1.4. Garanzia	5
1.5. Elenco dei pezzi ALASKA MINI	7
2. Montaggio della cabina	9
2.1. Montaggio del telaio di base	9
2.2. Montaggio degli elementi parete	10
2.3. Montaggio del tetto	17
2.4. Montaggio del pannello scorrevole di aerazione	19
2.5. Montaggio dell'allestimento interno	19
2.6. Montaggio accessori	25
2.7. Montaggio della porta in vetro	27
2.8. Montaggio del coronamento tetto	29
2.9. Montaggio del listello di copertura del tetto	30
3. Pianta	31
3.1. Pianta "a destra"	31
3.2. Pianta "a sinistra"	32
3.3. Differenze di montaggio per la pianta "a sinistra"	33

1. Preparazione per il montaggio

Leggere con attenzione le presenti istruzioni di montaggio e conservarle in prossimità della sauna. In questo modo è possibile controllare in qualsiasi momento le informazioni relative al prodotto.



Le presenti istruzioni di montaggio si trovano anche nella sezione download del nostro sito web all'indirizzo: www.sentiotec.com/downloads.

Indicazioni importanti:

- Prima di iniziare i lavori, controllare in base all'elenco dei pezzi se tutti i singoli componenti sono stati effettivamente forniti. Se eccezionalmente dovessero mancare dei singoli componenti, contattare il proprio fornitore entro 14 giorni dal ricevimento della cabina.
- L'ambiente in cui la cabina della sauna viene montata deve essere asciutto e garantire la circolazione dell'aria richiesta.
- Il pavimento deve essere orizzontale e uniforme, preferibilmente in pietra o piastrelle.
- Per i lavori di montaggio della cabina è necessaria un'altezza minima libera di 230 cm.
- Mantenere una distanza minima dalle pareti di 5 cm.
- I componenti in legno da utilizzare all'interno non devono essere trattati con impregnante.
- Per il montaggio è richiesto l'aiuto di una seconda persona.
- Il legno è un prodotto naturale che può gonfiarsi, ritirarsi o deformarsi anche se immagazzinato correttamente. In fase di montaggio potrebbe quindi essere necessario applicare una certa forza.
- Tutte le connessioni a vite devono essere preforate.

Attenzione!

Il collegamento elettrico deve essere eseguito da elettricisti specializzati o da persone con una qualifica simile.

1.1. Attrezzi necessari

- Martello e pezzo di legno oppure martello in gomma
- Avvitatore elettrico con punte per viti con testa a croce e viti Torx
- Metro a nastro avvolgibile
- Punte per trapano da 3 mm, 10 mm, 20-30 mm (per cavo elettrico della stufa per sauna)
- Livella a bolla
- Chiave a brugola da 1,5 mm
- Cutter
- Scala
- Seghetto



Questo simbolo indica consigli e indicazioni utili



Preforatura



Taglio alla lunghezza effettiva mediante seghetto



Verifica dell'ortogonalità:

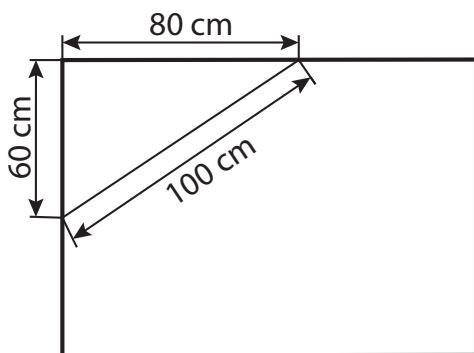

1.2. Manutenzione e pulizia

- La sauna deve essere pulita con un panno umido. Utilizzare solo acqua calda senza detersivi.
- Se la sauna non viene utilizzata per un tempo prolungato, si consiglia di riscaldare la cabina una volta al mese.

1.3. Smaltimento



- Smaltire i materiali dell'imballaggio conformemente alle normative sullo smaltimento vigenti.
- I vecchi apparecchi contengono materiali riciclabili ma anche sostanze dannose. Non gettare mai l'apparecchio usato insieme ai rifiuti non riciclabili, bensì smaltirlo in conformità alle norme vigenti a livello locale.

1.4. Garanzia

Offriamo una garanzia di cinque anni su tutte le nostre cabine in legno massiccio e le cabine a elementi delle linee sentiotec sauna e sentiotec infra per utilizzo privato. In caso di uso commerciale la garanzia è di due anni. Le cabine della linea hotline hanno una garanzia di due anni.

Requisiti per la garanzia:

- presentazione della fattura,
- presentazione di una descrizione dettagliata dei difetti,
- montaggio della cabina eseguito secondo le istruzioni di montaggio e d'uso sentiotec,
- richiesta di garanzia inoltrata a sentiotec entro il periodo di validità.

Sono esclusi dalla garanzia:

- difetti o danni derivati da un utilizzo non conforme all'uso previsto
- cabine modificate senza consenso esplicito del produttore
- tasche di resina
- fuoriuscita di resina
- danni e alterazioni cromatiche del legno dovuti a ventilazione insufficiente oppure a installazione in un luogo non adeguato
- cambiamenti naturali del legno come scolorimento, fessurazione, imbarca-mento, rigonfiamenti o altri cambiamenti dovuti alle caratteristiche naturali del legno

Le tasche di resina non sono motivo di reclamo perché nel legno di abete rosso sono sempre presenti e durante la selezione non è possibile rilevare a quale profondità si trovino. Quando sono appena al di sotto della superficie, con lo sviluppo del calore si rompono e possono "essudare". Rimuovere la resina fuoriuscita con un panno imbevuto di acetone. Se sono presenti solo gocce di resina, lasciarle indurire e poi raschiarle con cautela usando un coltello.

Il periodo di garanzia inizia con l'emissione della fattura da parte del produttore della cabina. Requisito per la garanzia è la presentazione della fattura originale. In assenza della fattura originale vale come riferimento per l'inizio del periodo di garanzia il mese di produzione indicato sulla targhetta del prodotto. Il periodo di garanzia non viene prolungato né rinnovato dalle prestazioni di garanzia.

La garanzia di cinque anni è un supplemento alle Condizioni generali di contratto della ditta sentiotec GmbH.

1.5. Elenco dei pezzi ALASKA MINI

Pz.	Denominazione	Dimensioni
Telaio di base		
1	Telaio di base	156 x 9 x 4 cm
1	Telaio di base	108 x 9 x 4 cm
1	Telaio di base	102 x 9 x 4 cm
1	Telaio di base	64 x 9 x 4 cm
Elementi parete		
1	Elemento di aerazione A/B con multclip	193 x 48 x 4 cm
1	Elemento parete A/B	193 x 48 x 4 cm
1	Elemento parete A/B con multclip	193 x 48 x 4 cm
4	Elementi parete A/B con multclip	193 x 48 x 4 cm
1	Elemento per cavi elettrici A/A con multclip	193 x 58 x 4 cm
1	Elemento sopraporta, pianta "a destra"	81,5 x 10,1 x 4 cm
1	Elemento sopraporta, pianta "a sinistra"	81,5 x 10,1 x 4 cm
Elementi del tetto		
2	Elementi del tetto	146 x 49 x 4 cm
Montante angolare		
3	Montante angolare 90° con multclip	193 x 6 x 6 cm
1	Montante angolare con incassatura anteriore per porta in vetro con multclip	202 x 6 x 7,5 cm
1	Montante per elemento in vetro, scanalatura di 8 mm	202 x 4,5 x 4 cm
Listelli di supporto		
2	Listelli di supporto del tetto	140 x 4 x 4 cm
2	Listelli di supporto del tetto	100 x 4 x 4 cm
2	Listelli di copertura del tetto	144 x 1,2 x 4 cm
2	Listelli di copertura del tetto	104 x 1,2 x 4 cm
2	Listelli di supporto panca	58 x 4 x 4 cm
2	Listelli di montaggio per pannello di rivestimento panca	26 x 4 x 4 cm

Pz. Denominazione**Dimensioni****Allestimento interno**

1	Panca	147 x 62 x 9 cm
1	Poggiapiedi	80 x 35 x 9 cm
2	Piedini poggiapiedi	43 x 33 x 4 cm
2	Sostegni poggiapiedi, 2x inclinati a 45°	49,5 x 8 x 2 cm
1	Schienale	138 x 26 x 4 cm
1	Pannello di rivestimento panca	147 x 35 x 4 cm
1	Griglia di protezione stufa – taglio	62,5 x 8 x 2 cm
1	Griglia di protezione stufa – taglio	37,5 x 8 x 2 cm
3	Listelli di montaggio per griglia di protezione stufa – abete rosso	7 x 2,5 x 2,5 cm
1	Poggiatesta	43 x 25 x 7 cm
1	Griglia di protezione lampada	38 x 32 x 4 cm
1	Pannello scorrevole di aerazione	52 x 14 x 1,5 cm

Elementi in vetro

1	Porta in vetro	191,5 x 59 x 0,8 cm
1	Elemento in vetro	194,5 x 22,4 x 0,8 cm

Listelli di coronamento tetto

1	Listello di coronamento tetto	160 x 6 x 4 cm
2	Listelli di coronamento tetto	115 x 6 x 4 cm

Accessori

1	Profilato a U in alluminio	21,1 x 1,2 x 1,5 cm
1	Set maniglia porta legno/Nirosta	
1	2 cerniere per porta 8653-02	
1	Magnete per porta, lamierino di battuta	
1	Lampada	
1	Dima per montaggio multiclip	
1	Cavo in silicone da 3 metri, 5 x 2,5 mm ²	
1	Cavo in silicone da 3 metri, 3 x 1,5 mm ²	
1	Set di materiale di montaggio	
1	Istruzioni di montaggio	

2. Montaggio della cabina

La cabina può essere montata “a destra” o “a sinistra”; consultare le piante a Pagina 31 e Pagina 32.

2.1. Montaggio del telaio di base



Punta per trapano da 3 mm, 3 viti 4 x 70 mm

IT



2.2. Montaggio degli elementi parete

I montanti angolari vengono collegati agli elementi parete mediante "multiclip".
Gli altri elementi parete vengono collegati con scanalatura e linguetta e avvitati tra loro.



A: indica sempre il lato a vista ed è riportata sulla parte superiore degli elementi parete.

Attenzione!

Di seguito viene descritta la sequenza di montaggio per la pianta "a destra".
Per le differenze di montaggio per la pianta "a sinistra" vedere Pagina 33.

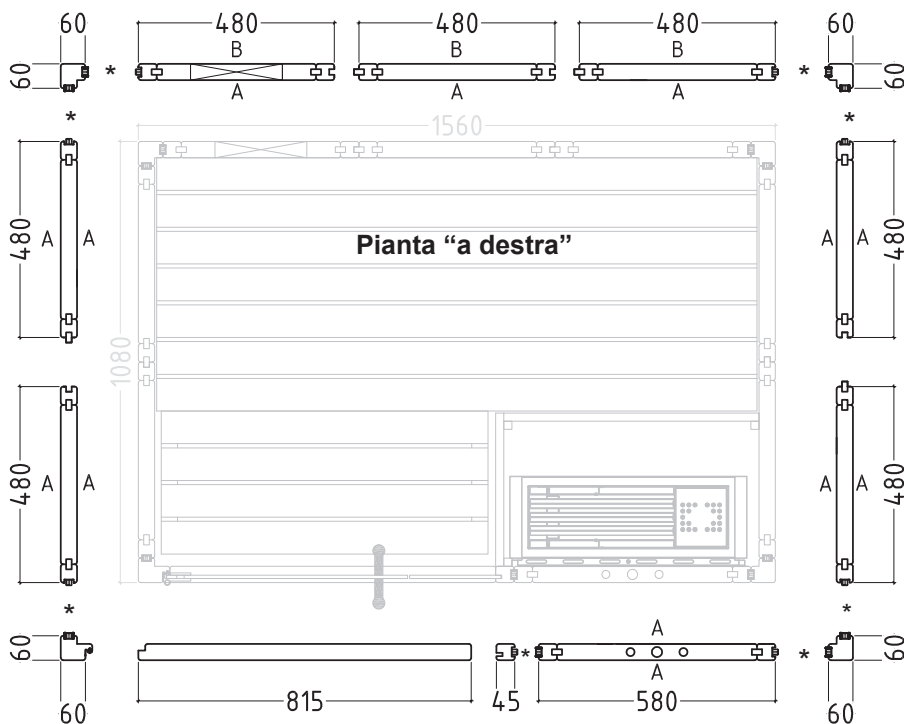

* Multiclip

Montaggio del montante angolare con elemento parete

Assemblare sul pavimento gli elementi parete con i montanti angolari e successivamente montarli sul telaio di base.

Innestare i montanti angolari dall'alto verso il basso sugli elementi parete. Nel farlo, prestare attenzione all'orientamento corretto delle "multiclip" (vedere sotto). I montanti devono essere a filo con gli elementi parete.

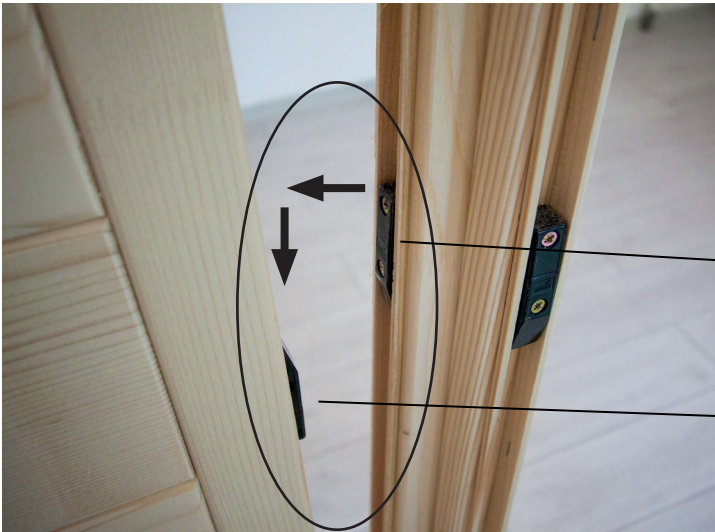

Multiclip



Montaggio degli elementi parete

L'elemento per cavi elettrici ha dei fori per la posa dei cavi. Per la posizione, vedere le piante a Pagina 31 e Pagina 32.



Elemento per cavi elettrici

Collegamento a vite degli elementi parete



Verificare l'ortogonalità degli elementi parete prima di avvitarli tra loro. Seguire l'indicazione a pagina 4.



Punta per trapano da 3 mm, 4 viti 4 x 70 mm

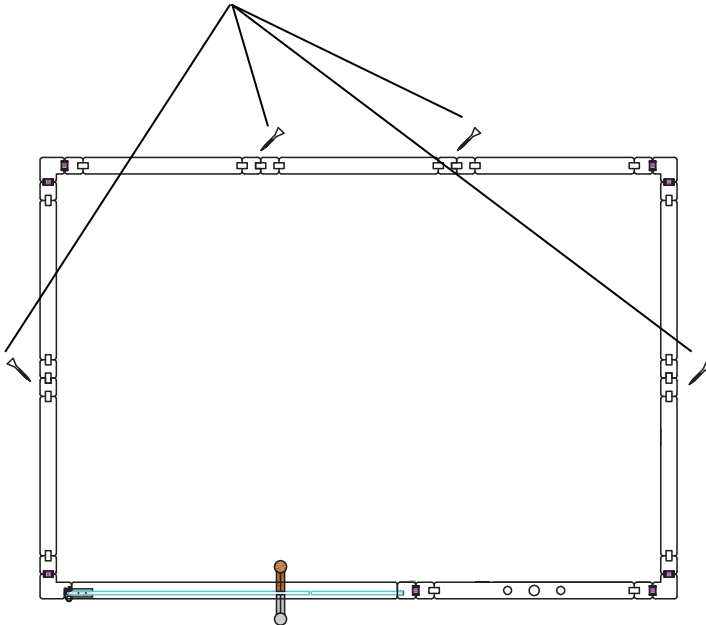

Montante angolare e montante per vetro



Elemento in vetro

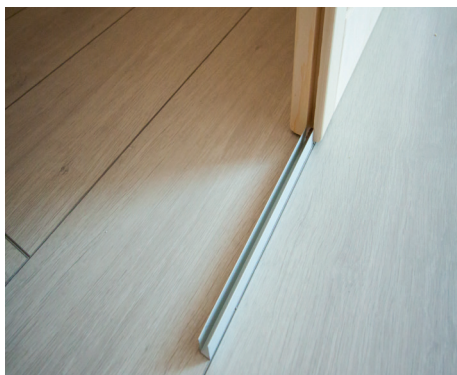

Elemento sopraporta

Selezionare l'elemento per pianta "a destra"





Punta per trapano da 3 mm, 2 viti 4 x 70 mm



2.3. Montaggio del tetto

Listelli di supporto del tetto



IT

Punta per trapano da 3 mm, 12 viti 4 x 70 mm



Elementi del tetto

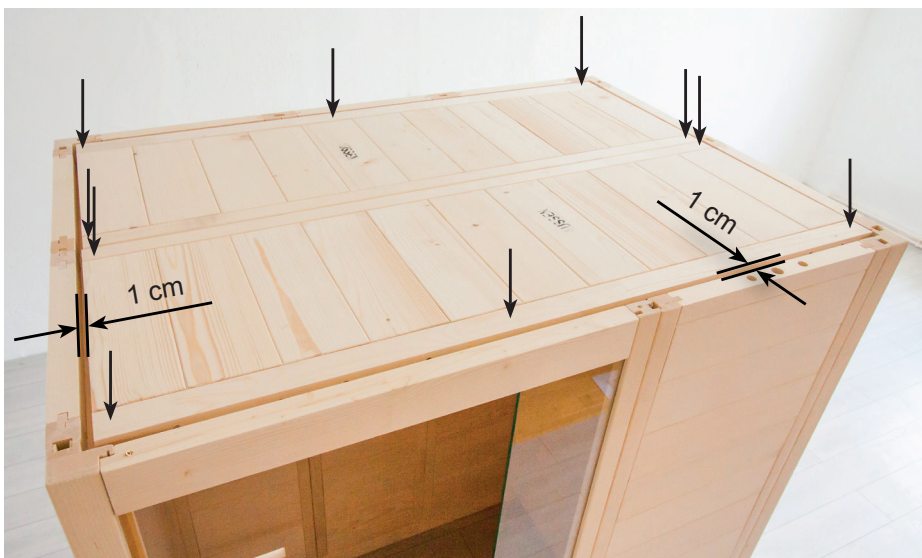

Punta per trapano da 3 mm, 10 viti 4 x 70 mm

2.4. Montaggio del pannello scorrevole di aerazione



Punta per trapano da 3 mm, 4 viti 3 x 40 mm

2.5. Montaggio dell'allestimento interno

Listelli di supporto panca

Punta per trapano da 3 mm, 3 viti 5 x 70 mm



2 viti 4 x 60 mm

Punta per trapano da 3 mm, 3 viti 5 x 70 mm

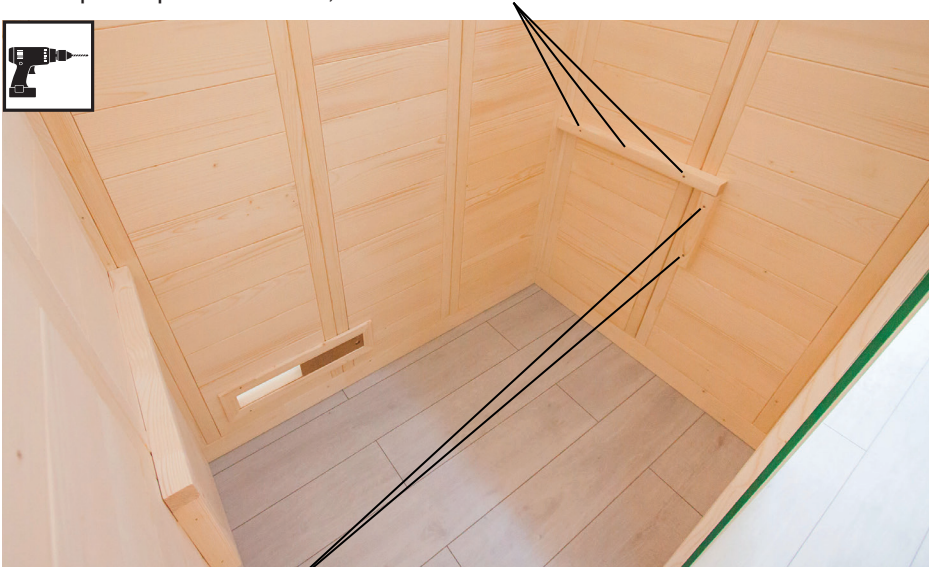

Viti 4 x 60 mm

Pannello di rivestimento panca



4 viti 4 x 60 mm

Panca



Poggiapiedi



6 viti 4 x 70 mm



4 viti 3,5 x 35 mm



Schienale



Punta per trapano da 3 mm, 3 viti 3 x 40 mm

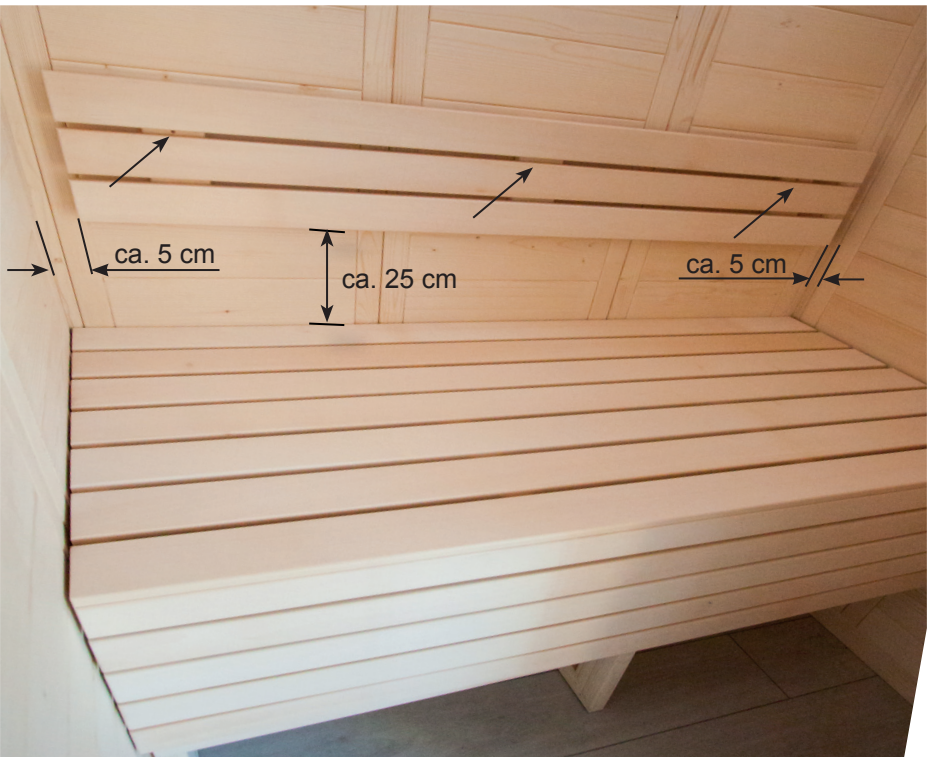

2.6. Montaggio accessori

Lampada



Inserire una lampadina
(non compresa nella fornitura)



Punta per trapano da 3 mm, 2 viti



4 viti 3 x 40 mm

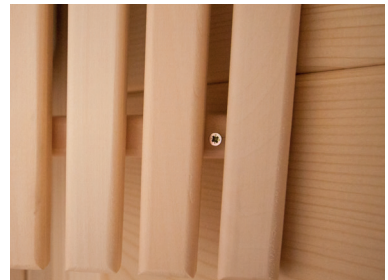

Griglia di protezione stufa

Prima del montaggio della griglia di protezione della stufa eseguire il foro di uscita per il cavo della stufa nell'elemento per cavi elettrici.

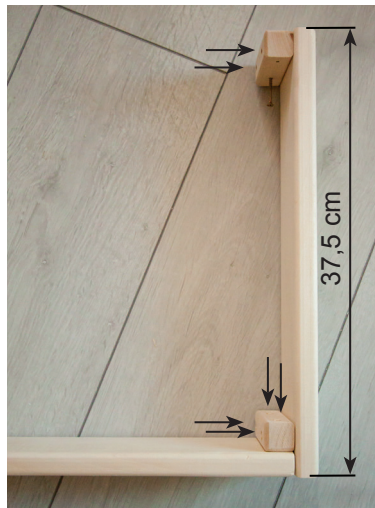

12 viti 3 x 40 mm

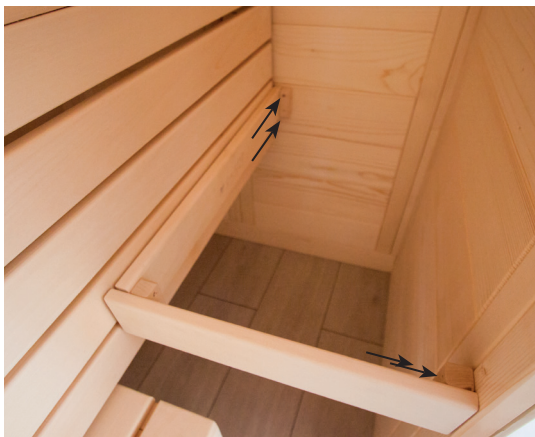

Griglia di protezione stufa accorciabile

2.7. Montaggio della porta in vetro



Il foro inferiore della maniglia porta è a un'altezza di 92,4 cm.
L'orientamento delle guarnizioni viene eseguito regolando / ruotando i due inserti in plastica.

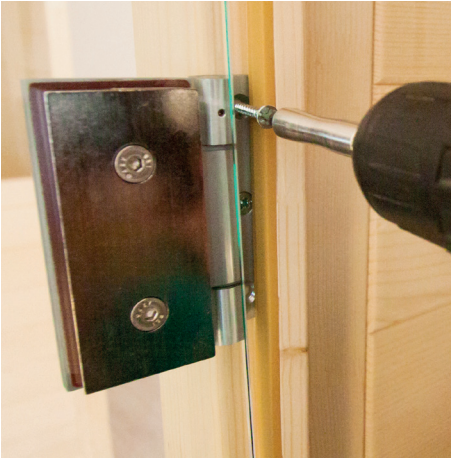
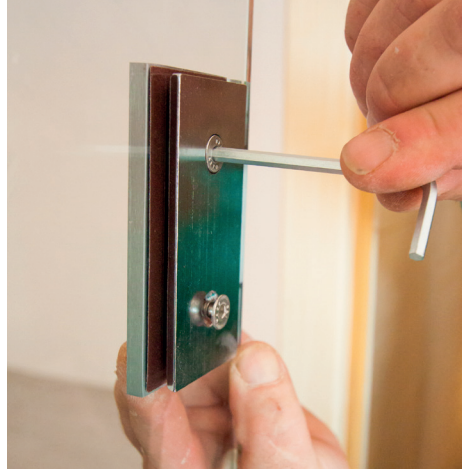
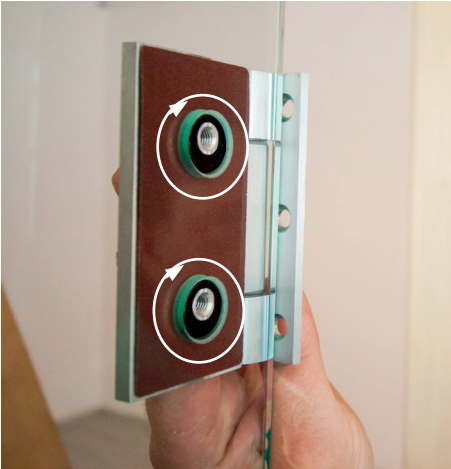

Maniglia porta e lamierino di battuta

Le maniglie vengono avvitate tra loro dall'interno.

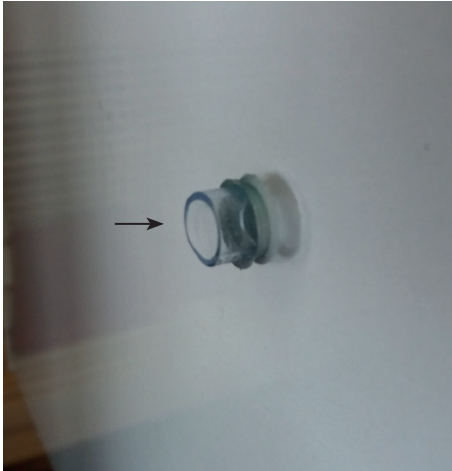

Inserire un anello di silicone nei fori



Applicare rondelle di plastica nelle maniglie Nirosta



2.8. Montaggio del coronamento tetto



Montare il coronamento tetto solo dopo aver inserito i cavi per la stufa della sauna e per il comando della sauna. Se possibile, ritagliare il listello dell'elemento per cavi elettrici.



Punta per trapano da 3 mm, 9 viti 3 x 40 mm

2.9. Montaggio del listello di copertura del tetto



Montare il listello di copertura del tetto solo dopo aver inserito i cavi per la stufa della sauna e per il comando della sauna. Se possibile, ritagliare il listello dell'elemento per cavi elettrici.



12 viti 3 x 40 mm

3. Pianta

3.1. Pianta "a destra"

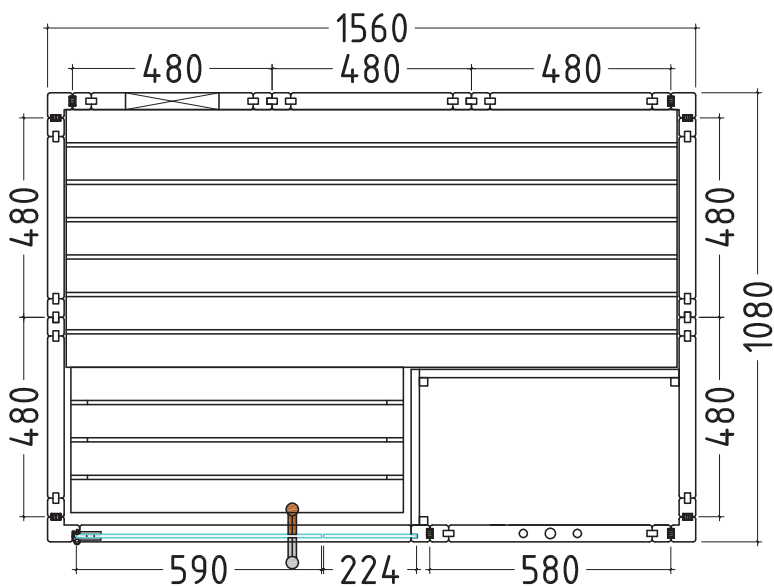

3.2. Pianta "a sinistra"

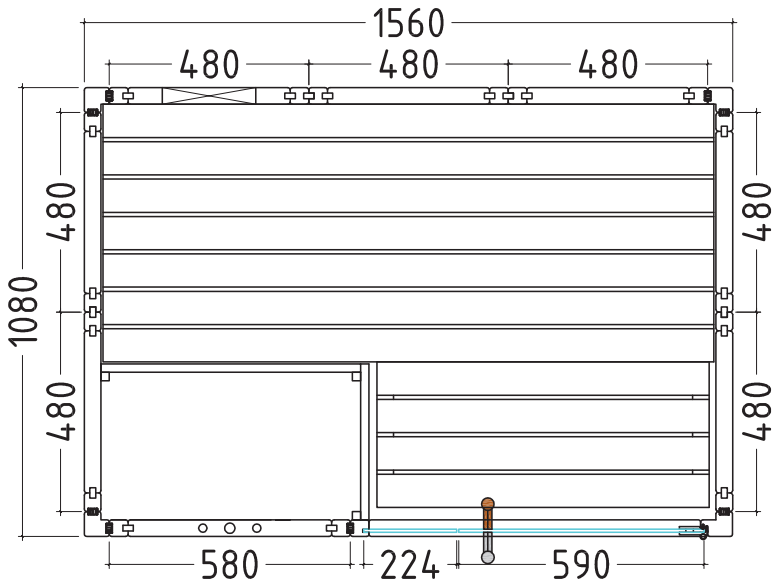

3.3. Differenze di montaggio per la pianta "a sinistra"

Per il montaggio di montante angolare e montante per il vetro (pagina 14)

Rimuovere le multiclip dal montante angolare e dal montante per il vetro.
Utilizzare la dima in dotazione per il nuovo posizionamento dei multiclip.



Elemento sopraporta (pagina 15)

Selezionare l'elemento per pianta "a sinistra"





sentiotec GmbH | Division of Harvia Group | Oberregauer Straße 48, A-4844 Regau
T +43 (0) 7672/277 20-567 | F -801 | info@sentiotec.com | www.sentiotec.com

Sauna z litego drewna

ALASKA

MINI

160 x 110 x 204 cm

INSTRUKCJA MONTAŻU

Polski



PL

Spis treści

1. Przygotowanie montażu	3
1.1. Wymagane narzędzia	4
1.2. Konserwacja i czyszczenie	5
1.3. Utylizacja	5
1.4. Gwarancja	5
1.5. Lista części ALASKA MINI	7
2. Montaż kabiny	9
2.1. Montaż ramy podłogowej	9
2.2. Montaż elementów ściennych	10
2.3. Montaż dachu	17
2.4. Montaż zasuwki do wentylacji	19
2.5. Montaż urządzenia wnętrza	19
2.6. Montaż akcesoriów	25
2.7. Montaż drzwi szklanych	27
2.8. Montaż występu dachu	29
2.9. Montaż listwy zakrywającej dach	30
3. Rzut poziomy	31
3.1. Rzut poziomy „na prawą stronę”	31
3.2. Rzut poziomy „na lewą stronę”	32
3.3. Zmiany w przypadku montażu „na lewą stronę”	33

1. Przygotowanie montażu

Przeczytaj uważnie niniejszą instrukcję montażu. Przechowuj ją w pobliżu sauny. Dzięki temu możliwe będzie w każdej chwili przeczytanie informacji o produkcie.



Niniejsza instrukcja montażu jest również dostępna do pobrania na naszej stronie internetowej www.sentiotec.com/downloads.

Ważne wskazówki:

- Przed rozpoczęciem pracy na podstawie listy części sprawdź, czy wszystkie części zostały faktycznie dostarczone. Jeśli brakuje którejkolwiek z części, poinformuj sprzedawcę najpóźniej 14 dni po otrzymaniu kabiny.
- Pomieszczenie, w którym zostanie zamontowana kabina sauny, musi być suche i zapewniać odpowiednią cyrkulację powietrza.
- Podłoga musi być pozioma i równa, preferowana podłoga kamienna lub podłoga wyłożona płytkami.
- Aby zamontować kabinę, pomieszczenie musi mieć minimalną wysokość wynoszącą 230 cm.
- Musi zostać zachowana odległość od ściany wynosząca co najmniej 5 cm.
- Części z drewna, które mają być użyte wewnątrz, nie mogą być lakierowane środkami impregnującymi.
- Do montażu potrzebna jest druga osoba.
- Drewno jest naturalnym produktem, który pomimo dobrego przechowywania może pęcznieć, kurczyć się lub wykrzywiać. Z tego powodu podczas montażu może być konieczne użycie siły.
- Wszystkie połączenia gwintowane muszą być nawiercone.

PL

Uwaga!

Podłączenie elektryczne może wykonywać tylko wykwalifikowany elektryk lub osoba posiadająca podobne kwalifikacje.

1.1. Wymagane narzędzia

- Młotek i przekładka z drewna lub młotek gumowy
- Wkrętarka akumulatorowa z bitami do wkrętów krzyżowych i Torx
- Taśma miernicza
- Wiertło o średnicy 3 mm, 10 mm, 20–30 mm (do przewodu zasilającego piec sauny)
- Poziomica
- Klucz imbusowy 1,5 mm
- Nóż uniwersalny
- Drabina
- Piła



Ten symbol oznacza rady i przydatne wskazówki



Wstępne wiercenie



Cięcie na miarę za pomocą piły



Sprawdzenie kąta prostego:

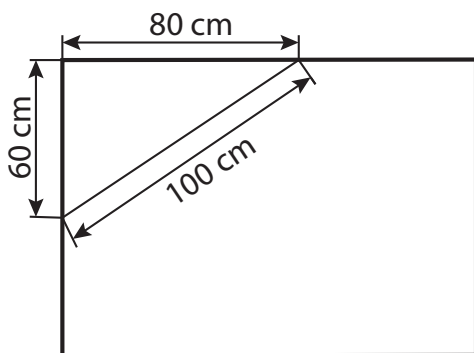

1.2. Konserwacja i czyszczenie

- Sauna powinna być czyszczona wilgotną ściereczką. Używaj tylko ciepłej wody – żadnych detergentów.
- Jeśli sauna nie jest używana przez dłuższy czas, zaleca się rozgrzewanie kabiny raz w miesiącu.

1.3. Utylizacja



- Utylizuj materiały opakowaniowe zgodnie z obowiązującymi odnośnymi dyrektywami.
- Zużyte urządzenia zawierają materiały możliwe do powtórnego przetworzenia jak również szkodliwe substancje. Dlatego nie umieszczaj ich w pojemniku na urządzenia nienadające się do powtórnego przetworzenia, lecz utylizuj je zgodnie z lokalnymi przepisami.

1.4. Gwarancja

Na wszystkie nasze kabiny z litego drewna i elementowe z linii sentiotec sauna oraz sentiotec infra udzielamy w sektorze prywatnym gwarancji na pięć lat. W przypadku użytku komercyjnego gwarancja wynosi dwa lata. W przypadku kabin z linii hotline gwarancja wynosi dwa lata.

Warunek gwarancji:

- Przedłożenie faktury zakupu,
- Dołączony dokładny opis błędu,
- Kabiny zostały zamontowane zgodnie z instrukcją montażu i obsługi firmy sentiotec,
- Roszczenie gwarancyjne wpłynie do firmy sentiotec w okresie gwarancyjnym.

Z gwarancji są wyłączone:

- Usterki lub szkody powstałe w wyniku użycia niezgodnego z przeznaczeniem
- Kabiny, które zostały zmodyfikowane bez wyraźnej zgody producenta
- Pęcherze żywiczne
- Żywica, która wypłynęła
- Uszkodzenia i odbarwienia drewna spowodowane niedostateczną wentylacją lub nieodpowiednim miejscem montażu
- Naturalne zmiany w drewnie, takie jak odbarwienia, pęknięcie, kurczenie, pęcznienie lub podobne zmiany spowodowane przez naturalne właściwości drewna

Pęcherze żywiczne nie są podstawą do reklamacji, ponieważ w drewnie świerkowym często zdarzają się pęcherze żywiczne i podczas sortowania nie można ocenić, na jakiej głębokości się one znajdują. Jeśli znajdują się one pod powierzchnią, przy wzroście temperatury mogą pęknąć i wypłynąć. Żywicę, która wypłynęła, należy usunąć za pomocą szmatki zamoczonej w acetonie. Jeśli powstaną tylko kropelki żywicy, należy poczekać, aż stwardnieją, i następnie ostrożnie zeszkrobać nożem.

Okres gwarancji rozpoczyna się od daty wystawienia faktury producenta kabiny. Warunkiem jest przedstawienie oryginalnej faktury. Jeśli nie ma oryginalnej faktury, miesiąc produkcji, który jest oznaczony na tabliczce znamionowej, służy jako podstawa do rozpoczęcia okresu gwarancyjnego. Okres gwarancyjny nie jest ani przedłużany ani odnawiany poprzez udzielenie gwarancji.

Pięcioletnia gwarancja jest dodatkiem do ogólnych warunków handlowych firmy sentiotec GmbH.

1.5. Lista części ALASKA MINI

II. Nazwa	Wymiar
Rama podłogi	
1 Rama podłogi	156 x 9 x 4 cm
1 Rama podłogi	108 x 9 x 4 cm
1 Rama podłogi	102 x 9 x 4 cm
1 Rama podłogi	64 x 9 x 4 cm
Elementy ścienne	
1 Element wentylacyjny A/B z multiklipem	193 x 48 x 4 cm
1 Element ścienny A/B	193 x 48 x 4 cm
1 Element ścienny A/B z multiklipem	193 x 48 x 4 cm
4 Element ścienny A/A z multiklipem	193 x 48 x 4 cm
1 Element elektryczny A/A z multiklipem	193 x 58 x 4 cm
1 Element nad drzwiami, rzut poziomy „po prawej stronie”	81,5 x 10,1 x 4 cm
1 Element nad drzwiami, rzut poziomy „po lewej stronie”	81,5 x 10,1 x 4 cm
Elementy dachowe	
2 Elementy dachowe	146 x 49 x 4 cm
Stojak narożny	
3 Stojak narożny 90° z multiklipem	193 x 6 x 6 cm
1 Stojak narożny z wpustem z przodu na drzwi szklane z multiklipem	202 x 6 x 7,5 cm
1 Stojak na element szklany 8 mm wpust	202 x 4,5 x 4 cm
Listwy nakładane	
2 Listwy nakładane na dach	140 x 4 x 4 cm
2 Listwy nakładane na dach	100 x 4 x 4 cm
2 Listwy zakrywające dach	144 x 1,2 x 4 cm
2 Listwy zakrywające dach	104 x 1,2 x 4 cm
2 Listy nakładane na ławkę	58 x 4 x 4 cm
2 Listwy montażowe do osłony ławki	26 x 4 x 4 cm

II. Nazwa**Wymiar****Urządzenie wnętrza**

1 Ławka	147 x 62 x 9 cm
1 Płyta podnóżkowa	80 x 35 x 9 cm
2 Podnóżek na stopy	43 x 33 x 4 cm
2 Podnóżek z podporą, 2 x 45° ukośną	49,5 x 8 x 2 cm
1 Oparcie na plecy	138 x 26 x 4 cm
1 Osłona ławki	147 x 35 x 4 cm
1 Krata ochronna pieca – lipa	62,5 x 8 x 2 cm
1 Krata ochronna pieca – lipa	37,5 x 8 x 2 cm
3 Listwy montażowe do kraty ochronnej pieca – świerk	7 x 2,5 x 2,5 cm
1 Zagłówek	43 x 25 x 7 cm
1 Krata ochronna lampy	38 x 32 x 4 cm
1 Zasuwka do wentylacji	52 x 14 x 1,5 cm

Elementy szklane

1 Drzwi szklane	191,5 x 59 x 0,8 cm
1 Element szklany	194,5 x 22,4 x 0,8 cm

Występy dachu

1 Występ dachu	160 x 6 x 4 cm
2 Występy dachu	115 x 6 x 4 cm

Akcesoria

1 Profil aluminiowy U	21,1 x 1,2 x 1,5 cm
1 Uchwyt drzwiowy – zestaw drewno/Niro	
1 2 zawiasy drzwiowe 8653-02	
1 Magnes drzwiowy, blacha nakładana z góry	
1 Lampa do sauny	
1 Szablon do montażu multiklipa	
1 3 mb Przewód silikonowy 5 x 2,5 mm ²	
1 3 mb Przewód silikonowy 3 x 1,5 mm ²	
1 Zestaw materiałów montażowych	
1 Instrukcja montażu	

2. Montaż kabiny

Kabina może zostać zamontowana „na prawą stronę lub „na lewą stronę”, należy sprawdzić plany rzutu poziomego na Strona 31 oraz Strona 32.

2.1. Montaż ramy podłogowej

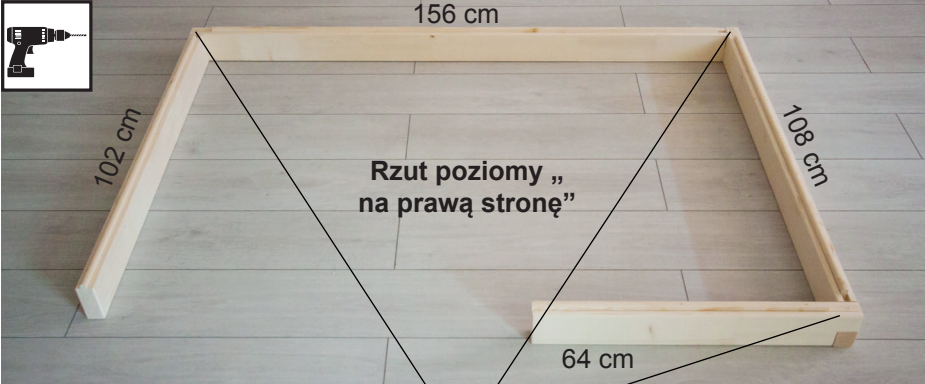

Wiertło 3 mm, 3 szt. śrub 4 x 70 mm

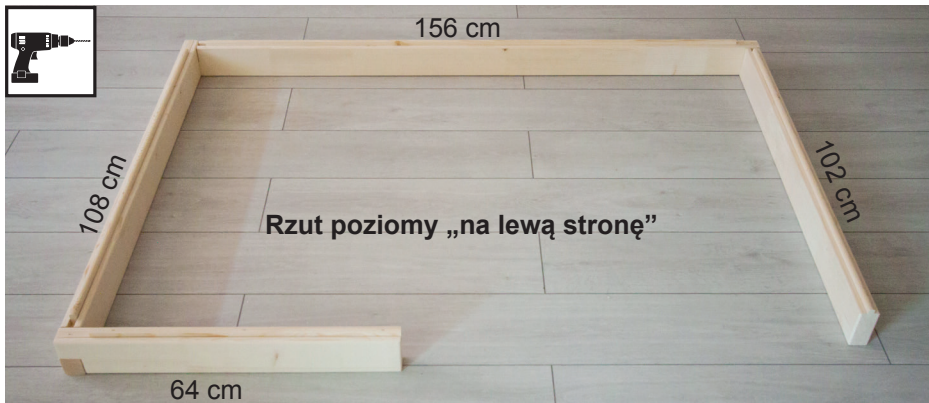

2.2. Montaż elementów ściennych

Stojaki narożne są łączone za pomocą „multiklipów” z elementami ściennymi. Pozostałe elementy ścienne są łączone na pióro i wpust i są połączone śrubami.



A wskazuje zawsze na stronę widoczną, jest ona oznaczana na górze elementów ściennych.

Uwaga!

Poniżej opisano montaż dla rzutu poziomowego „na prawą stronę”.

Aby zapoznać się ze zmianami montażu dla rzutu poziomowego „na lewą stronę” – zob. Strona 33.

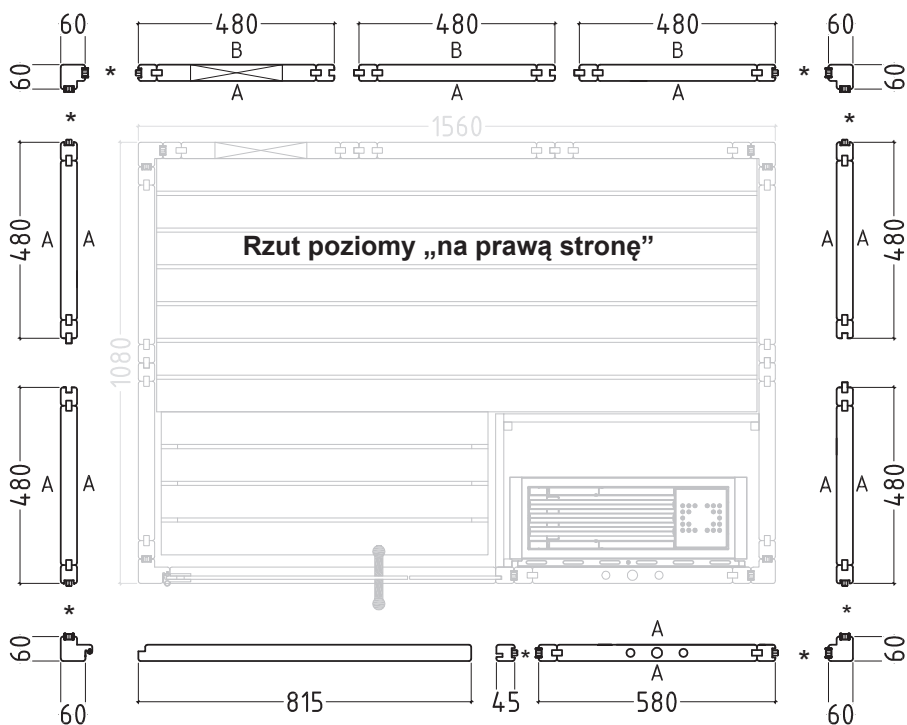

* Multiklips

Montaż stojaka narożnego z elementem ściennym

 Zamontuj elementy ścienne ze stojakami narożnymi na podłodze, a następnie umieść te stojaki na ramie podłogi.

Nasuń stojak narożny z góry na dół na elementy ścienne. Upewnij się, że multiklipsy są poprawnie ustawione (zob. poniżej). Stojak narożny musi znajdować się w jednej płaszczyźnie z elementami ściennymi.

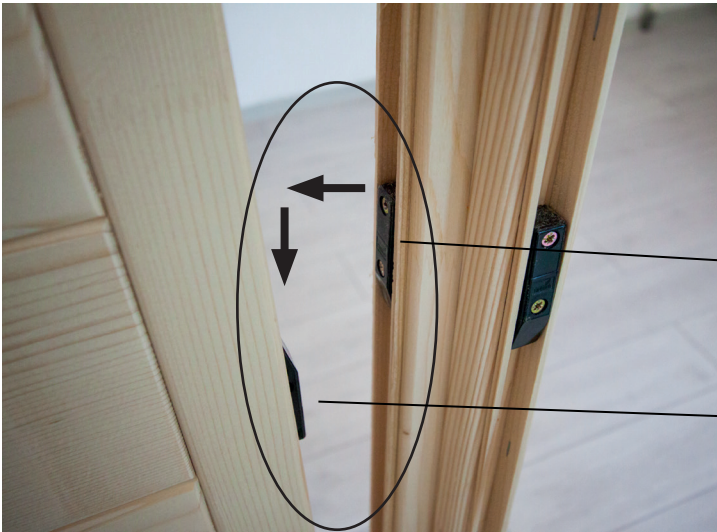

Multiklip



Montaż elementów ściennych

Element elektryczny ma otwory do układania przewodów. Sprawdź położenie na planie rzutów poziomych na Strona 31 i Strona 32.



Element elektryczny

Łączenie śrubami elementów ściennych

Sprawdź kąt prosty przed połączeniem elementów ściennych śrubami.
Postępuj zgodnie ze wskazówką na stronie 4.



Wiertło 3 mm, 4 szt. śrub 4 x 70 mm

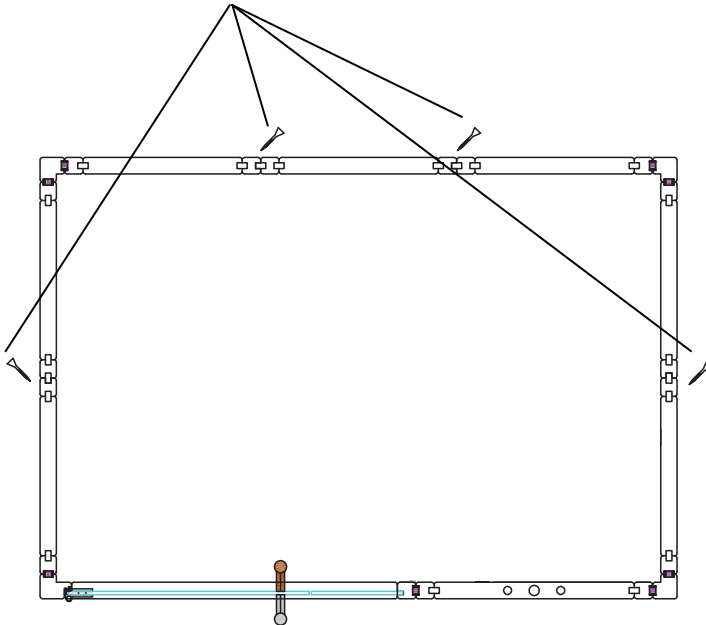

Stojak narożny i stojak na szkło

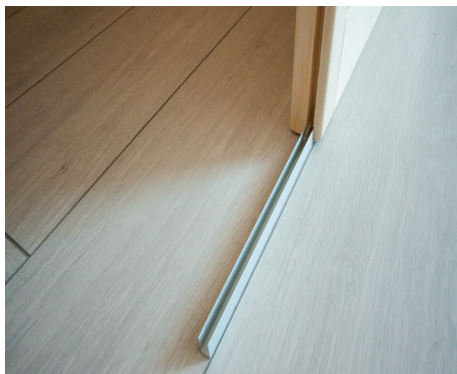

Element szklany**Element powyżej drzwi**

Wybierz element z rzutu poziomowego „na prawą stronę”





Wiertło 3 mm, 2 szt. śrub 4 x 70 mm

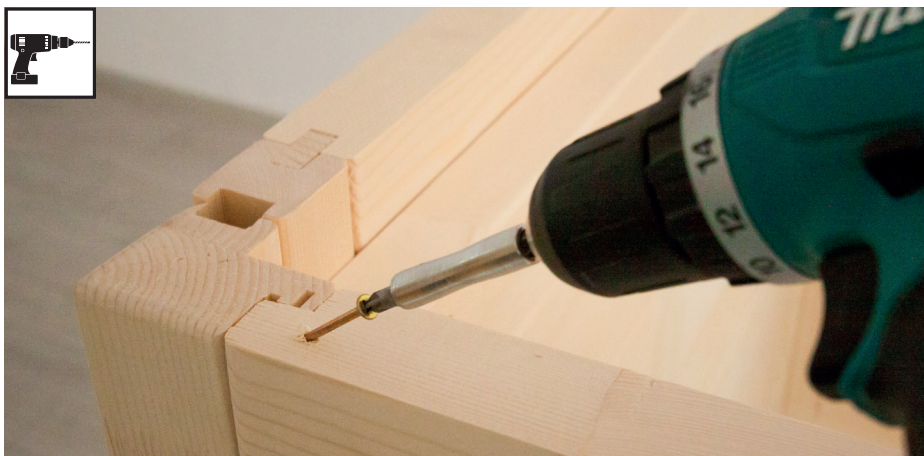

2.3. Montaż dachu

Listwy nakładane na dachu



Wiertło 3 mm, 12 szt. śrub 4 x 70 mm

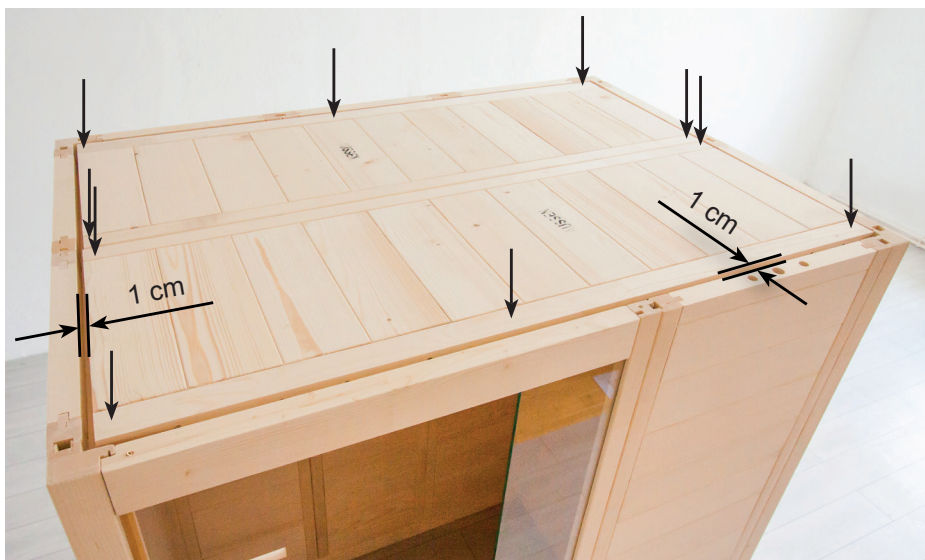

Elementy dachowe

Wiertło 3 mm, 10 szt. śrub 4 x 70 mm

2.4. Montaż zasuwki do wentylacji



Wiertło 3 mm, 4 szt. śrub 3 x 40 mm

2.5. Montaż urządzenia wnętrza

Listy nakładane na ławkę

Wiertło 3 mm, 3 szt. śrub 5 x 70 mm



2 szt. śrub 4 x 60 mm

Wiertło 3 mm, 3 szt. śrub 5 x 70 mm



Śruby 4 x 60 mm

Ośłona ławki

4 szt. śrub 4 x 60 mm

Ławka

Podnózek



6 szt. śrub 4 x 70 mm



4 szt. śrub 3,5 x 35 mm



Oparcie na plecy

Wiertło 3 mm, 3 szt. śrub 3 x 40 mm

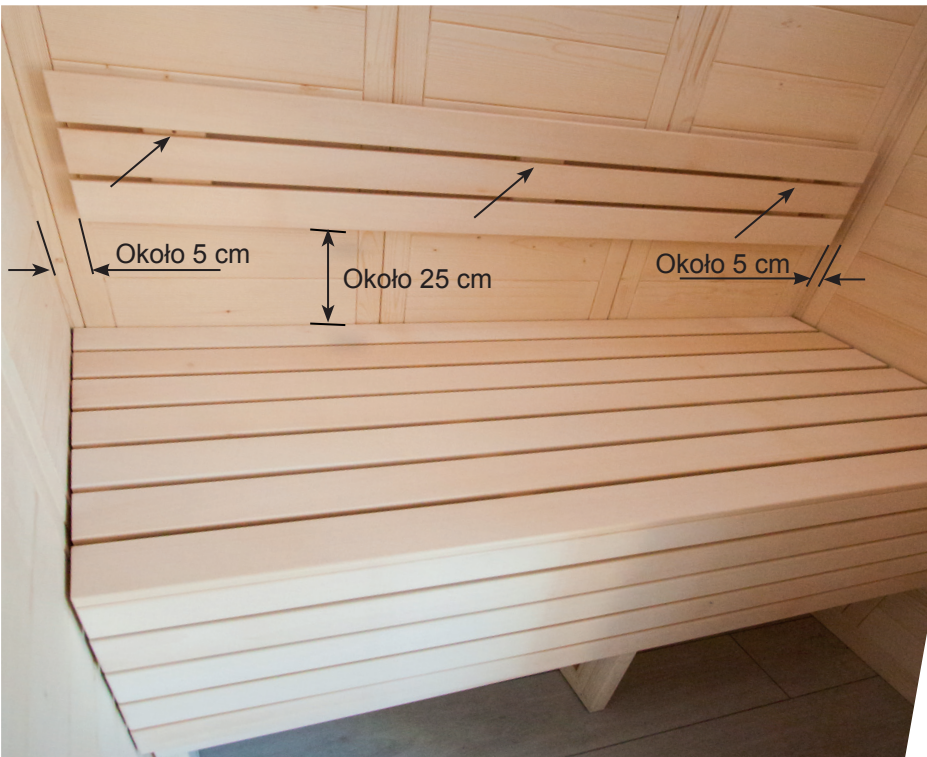

2.6. Montaż akcesoriów

Lampa do sauny



Zamontuj lampę
(nie wchodzi w zakres dostawy)



Wiertło 3 mm, 2 szt. śrub



4 szt. śrub 3 x 40 mm

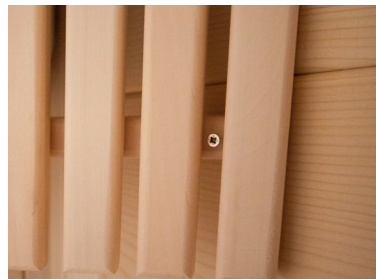

PL

Krata ochronna pieca

 Przed montażem kraty ochronnej pieca wywierć w elemencie elektrycznym wylot na przewód pieca.



12 szt. śrub 3 x 40 mm



Można indywidualnie przyciąć kratę ochronną pieca

2.7. Montaż drzwi szklanych



Dolny otwór uchwyty drzwiowego znajduje się na wysokości 92,4 cm. Ustawienie okuć wykonuje się poprzez wyrównanie/obróć obu wkładek wykonanych z tworzywa sztucznego.

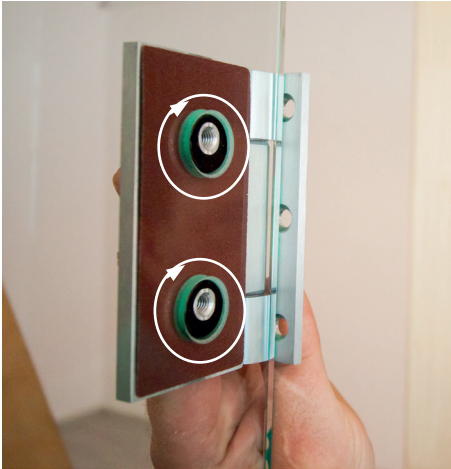

Uchwyt drzwiowy i blacha nakładana z góry

Uchwyty drzwi są łączone ze sobą śrubami od wewnątrz.

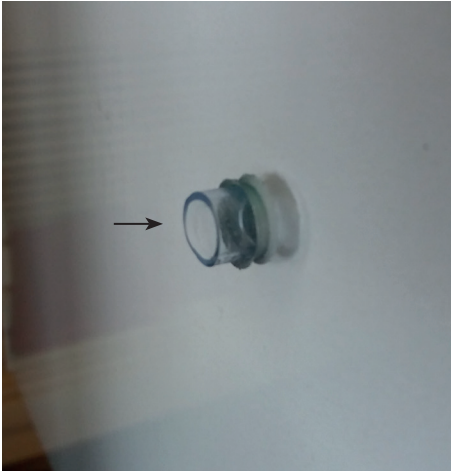

Włóż pierścień silikonowy do otworów



Włóż podkładki z tworzywa sztucznego do uchwytu Niro



2.8. Montaż występu dachu



Zamontuj występ dachu dopiero po przeprowadzeniu przewodu do pieca sauny i sterowania sauną. Listwa może wymagać wycięcia w elemencie elektrycznym.



Wiertło 3 mm, 9 szt. śrub 3 x 40 mm

2.9. Montaż listwy zakrywającej dach



Zamontuj listwę zakrywającą dach dopiero po przeprowadzeniu przewodu do pieca sauny i sterowania sauną. Listwa może wymagać wycięcia w elemencie elektrycznym.



12 szt. śrub 3 x 40 mm

3. Rzut poziomy

3.1. Rzut poziomy „na prawą stronę”

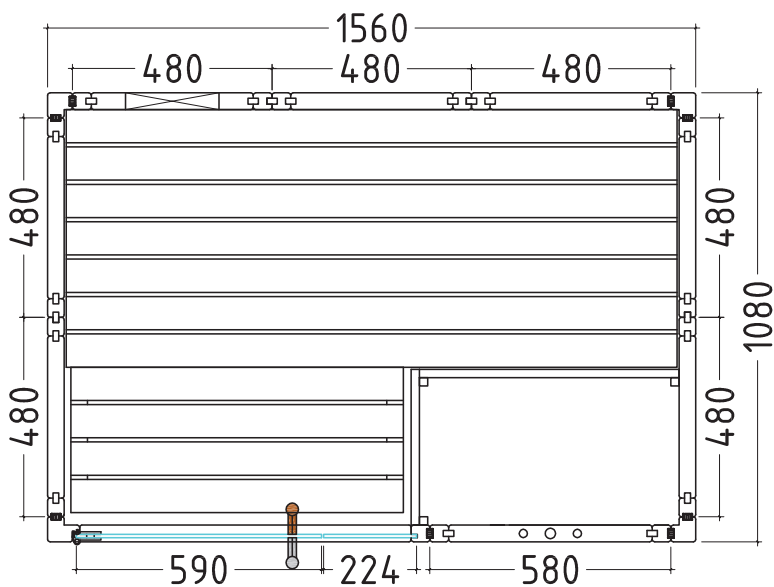

3.2. Rzut poziomy „na lewą stronę”

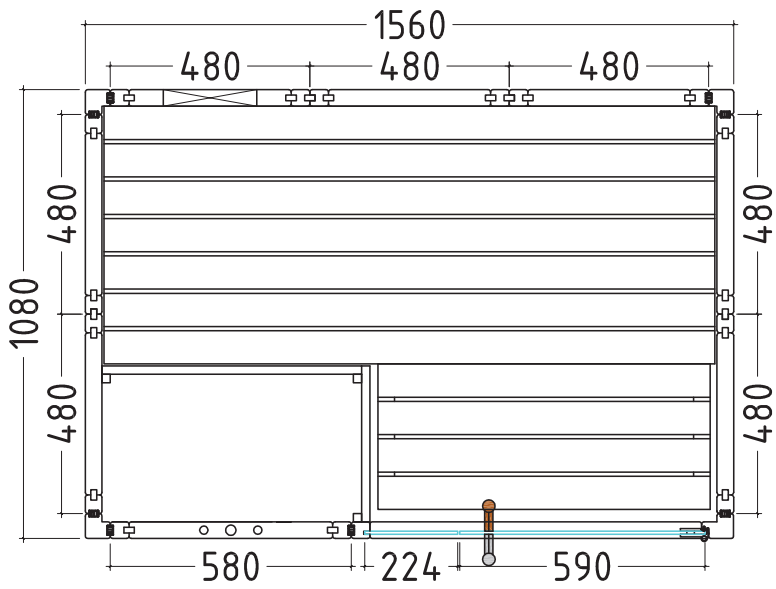

3.3. Zmiany w przypadku montażu „na lewą stronę“

W przypadku montażu stojaka narożnego i stojaka na szkło (strona 14)

Usuń multiklipy ze stojaka narożnego i stojaka na szkło.

Użyj dołączonego szablonu do nowego ustawienia multiklipów.



Element powyżej drzwi (strona 15)

Wybierz element z rzutu poziomowego na lewą stronę





sentiotec GmbH | Division of Harvia Group | Oberregauer Straße 48, A-4844 Regau
T +43 (0) 7672/277 20-567 | F -801 | info@sentiotec.com | www.sentiotec.com

Sauna maciça

ALASKA

MINI

160 x 110 x 204 cm

MANUAL DE MONTAGEM
Português



PT

Índice

1. Preparação para a montagem	3
1.1. Ferramentas necessárias	4
1.2. Manutenção e limpeza	5
1.3. Eliminação	5
1.4. Garantia	5
1.5. Lista de peças da ALASKA MINI	7
2. Montagem da cabina	9
2.1. Montagem da armação do chão	9
2.2. Montagem dos elementos de parede	10
2.3. Montagem do teto	17
2.4. Montagem da corrediça de ventilação	19
2.5. Montagem do equipamento interior	19
2.6. Montagem dos acessórios	25
2.7. Montagem da porta de vidro	27
2.8. Montagem do friso do teto	29
2.9. Montagem da barra de cobertura do teto	30
3. Plano	31
3.1. Plano “à direita”	31
3.2. Plano “à esquerda”	32
3.3. Alterações na montagem do plano “à esquerda”	33

1. Preparação para a montagem

Leia atentamente o manual de montagem e guarde-o nas proximidades da sauna. Poderá, assim, ler as informações sobre o produto a qualquer momento posteriormente.



Este manual de montagem também está disponível na área de downloads da nossa página web em www.sentiotec.com/downloads.

Indicações importantes:

- Antes de começar a trabalhar, verifique, com base na lista de peças, se todas as peças individuais foram efetivamente fornecidas. Se, excepcionalmente, faltarem peças individuais, informe o seu distribuidor num período máximo de 14 dias após a receção da cabina.
- O espaço em que a cabina da sauna é montada tem de ser seco e garantir uma circulação de ar adequada.
- O piso tem de ser horizontal e plano, de preferência um pavimento em mosaico ou pedra.
- Para os trabalhos de montagem da cabina é necessária uma altura mínima de 230 cm.
- Manter impreterivelmente uma distância mínima de 5 cm em relação à parede.
- As peças em madeira a utilizar no interior não podem ser tratadas com agentes impregnantes.
- Para a montagem é necessária uma pessoa auxiliar.
- A madeira é um produto natural que, apesar de um bom armazenamento, pode dilatar, encolher ou sofrer deformações. Por isso, é possível que seja necessário exercer um pouco de força durante a montagem.
- Todos os aparafusamentos têm de ser perfurados previamente.

Atenção!

A ligação elétrica só pode ser executada por um electricista ou por uma pessoa com formação equivalente.

1.1. Ferramentas necessárias

- Martelo e madeira suplementar ou um martelo de borracha
- Aparafusadora sem fios com pontas para parafusos em cruz e Torx
- Rolo de fita métrica
- Brocas com um diâmetro de 3 mm, 10 mm, 20–30 mm (para o cabo de alimentação do aquecedor de sauna)
- Nível de bolha de ar
- Chave de sextavado interior de 1,5 mm
- Faca universal
- Escadote
- Serrote



Este símbolo identifica dicas e indicações úteis



Perfuração prévia



Corte à medida com serrote



Verificação do ângulo direito:

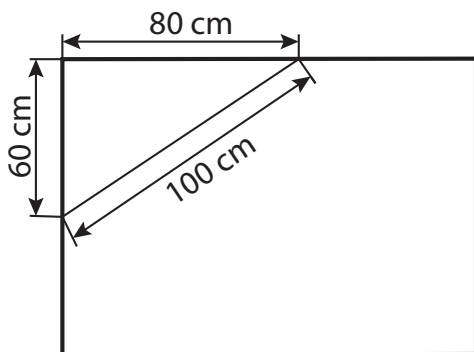

1.2. Manutenção e limpeza

- A sauna deverá ser limpa com um pano húmido. Utilize apenas água quente. Não utilize qualquer produto de limpeza.
- Se a sauna não for utilizada por um longo período, recomendamos que aqueça a cabina uma vez por mês.

1.3. Eliminação



- Elimine os materiais da embalagem de acordo com as diretivas de eliminação em vigor.
- Os aparelhos usados contêm materiais reutilizáveis, mas também substâncias perigosas. Por isso, não deite, sob circunstância alguma, o seu aparelho usado no lixo residual. Elimine-o, sim, de acordo com as disposições válidas localmente.

1.4. Garantia

Todas as nossas cabinas maciças e de elementos da linha sentiotec sauna e sentiotec infra do setor privado dispõem de uma garantia de cinco anos. Numa utilização comercial, a garantia é de dois anos. Para cabinas da linha hotline, a garantia é de dois anos.

Requisitos para usufruir da garantia:

- Apresentação da respetiva fatura,
- Inclusão de uma descrição detalhada do erro,
- Montagem das cabinas em conformidade com os manuais de montagem e de utilização sentiotec,
- Reivindicação do direito de garantia junto da sentiotec dentro do período de garantia.

Estão excluídos da garantia:

- Falhas ou danos resultantes de uma utilização incorreta
- Cabinas que foram modificadas sem o consentimento expresso do fabricante
- Cavidades com resina
- Fugas de resina
- Danos e descolorações na madeira devido a uma ventilação insuficiente ou a um local de instalação inadequado
- Alterações naturais da madeira como descolorações, formação de fendas, encolhimento, dilatações ou alterações semelhantes decorrentes das propriedades naturais da madeira

As cavidades com resina não são qualquer motivo de reclamação, uma vez que estas surgem de forma recorrente na madeira de abeto e não é possível detetar, no momento da separação, a profundidade a que se encontram. Quando estas se encontram pouco abaixo da superfície, emergem com a formação de calor e começam a “sangrar”. Remover as fugas de resina com um pano embebido em acetona. Se surgirem apenas gotas de resina, deixe-as secar e, depois, raspe-as cuidadosamente com uma faca.

O período de garantia inicia no momento da criação da fatura do fabricante da cabina. Um requisito para a prestação da garantia é a apresentação da fatura original. Se a fatura original não estiver disponível, serve de referência para o início do período de garantia o mês de produção que consta da placa de identificação do produto. O prazo de garantia não é prolongado nem renovado por serviços prestados ao abrigo da garantia.

A garantia de cinco anos é um complemento das condições gerais de venda da sentiotec GmbH.

1.5. Lista de peças da ALASKA MINI

Quant.	Designação	Medida
Armação do chão		
1	Armação do chão	156 x 9 x 4 cm
1	Armação do chão	108 x 9 x 4 cm
1	Armação do chão	102 x 9 x 4 cm
1	Armação do chão	64 x 9 x 4 cm
Elementos de parede		
1	Elemento de ventilação A/B com multiclipse	193 x 48 x 4 cm
1	Elemento de parede A/B	193 x 48 x 4 cm
1	Elemento de parede A/B com multiclipse	193 x 48 x 4 cm
4	Elementos de parede A/A com multiclipse	193 x 48 x 4 cm
1	Elemento elétrico A/A com multiclipse	193 x 58 x 4 cm
1	Elemento acima da porta, plano “à direita”	81,5 x 10,1 x 4 cm
1	Elemento acima da porta, plano “à esquerda”	81,5 x 10,1 x 4 cm
Elementos do teto		
2	Elementos do teto	146 x 49 x 4 cm
Suportes de canto		
3	Suporte de canto 90° com multiclipse	193 x 6 x 6 cm
1	Suporte de canto com dobra à frente para porta de vidro com multiclipse	202 x 6 x 7,5 cm
1	Suporte para elemento de vidro, ranhura de 8 mm	202 x 4,5 x 4 cm
Barras de apoio		
2	Barras de apoio para o teto	140 x 4 x 4 cm
2	Barras de apoio para o teto	100 x 4 x 4 cm
2	Barras de cobertura para o teto	144 x 1,2 x 4 cm
2	Barras de cobertura para o teto	104 x 1,2 x 4 cm
2	Barras de apoio para o banco	58 x 4 x 4 cm
2	Barras de montagem para o anteparo do banco	26 x 4 x 4 cm

Quant.	Designação	Medida
Equipamento interior		
1	Banco	147 x 62 x 9 cm
1	Placa do degrau	80 x 35 x 9 cm
2	Pés do degrau	43 x 33 x 4 cm
2	Escora do degrau, inclinação 2 x 45°	49,5 x 8 x 2 cm
1	Encosto	138 x 26 x 4 cm
1	Anteparo do banco	147 x 35 x 4 cm
1	Grelha de proteção do aquecedor – tília	62,5 x 8 x 2 cm
1	Grelha de proteção do aquecedor – tília	37,5 x 8 x 2 cm
3	Barras de montagem para a grelha de proteção do aquecedor – abeto	7 x 2,5 x 2,5 cm
1	Apoio para a cabeça	43 x 25 x 7 cm
1	Grelha de proteção da lâmpada	38 x 32 x 4 cm
1	Corrediça de ventilação	52 x 14 x 1,5 cm
Elementos de vidro		
1	Porta de vidro	191,5 x 59 x 0,8 cm
1	Elemento de vidro	194,5 x 22,4 x 0,8 cm
Barras do friso do teto		
1	Barra do friso do teto	160 x 6 x 4 cm
2	Barras do friso do teto	115 x 6 x 4 cm
Acessórios		
1	Perfil de alumínio em U	21,1 x 1,2 x 1,5 cm
1	Conjunto de puxador da porta em madeira/aço inoxidável	
1	2 dobradiças de porta 8653-02	
1	Ímã da porta, chapa de transferência	
1	Luz da sauna	
1	Molde para a montagem dos multiclipos	
1	Cabo de silicone 3 m. lin., 5 x 2,5 mm ²	
1	Cabo de silicone 3 m. lin., 3 x 1,5 mm ²	
1	Conjunto de material de montagem	
1	Manual de montagem	

2. Montagem da cabina

A cabina pode ser montada “à direita” ou “à esquerda”. A este respeito, tenha em atenção os planos nas páginas Página 31 e Página 32.

2.1. Montagem da armação do chão



Broca de 3 mm, 3 parafusos de 4 x 70 mm



2.2. Montagem dos elementos de parede

Os suportes de canto são ligados aos elementos de parede através de “multicliques”. Os outros elementos de parede são ligados por meio de ranhuras e molas e aparafusados uns aos outros.



A designa sempre o lado visível. Este está identificado na parte superior dos elementos de parede.

Atenção!

De seguida, é descrita a montagem para o plano “à direita”.

Para alterações relativas à montagem para o plano “à esquerda”, consulte a página Página 33.

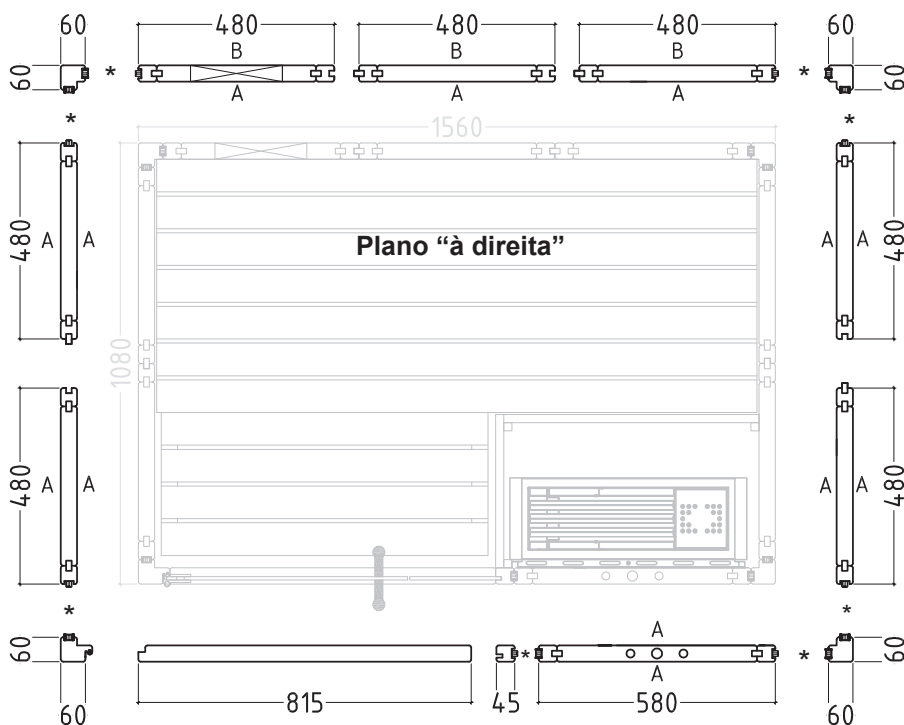

* Multicliques

Montagem dos suportes de canto com os elementos de parede

Monte previamente os elementos de parede com os suportes de canto no chão e coloque depois esses cantos sobre a armação do chão.

Insira o suporte de canto nos elementos de parede, de cima para baixo. Ao fazê-lo, tenha em atenção o alinhamento correto dos “multiclipes” (ver em baixo). O suporte de canto tem de ficar alinhado com os elementos de parede.

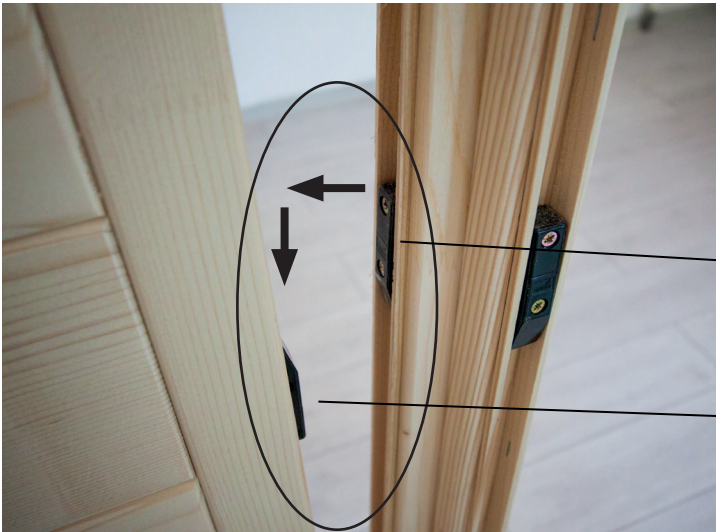

Multiclipe



Montagem dos elementos de parede

O elemento elétrico dispõe de orifícios para passar os cabos.
Consulte a posição nos planos, nas páginas Página 31 e Página 32.



Elemento elétrico

Aparafusamento dos elementos de parede

 Verifique os ângulos direitos antes de aparafusar os elementos de parede. Tenha em atenção a dica na página 4.



Broca de 3 mm, 4 parafusos de 4 x 70 mm

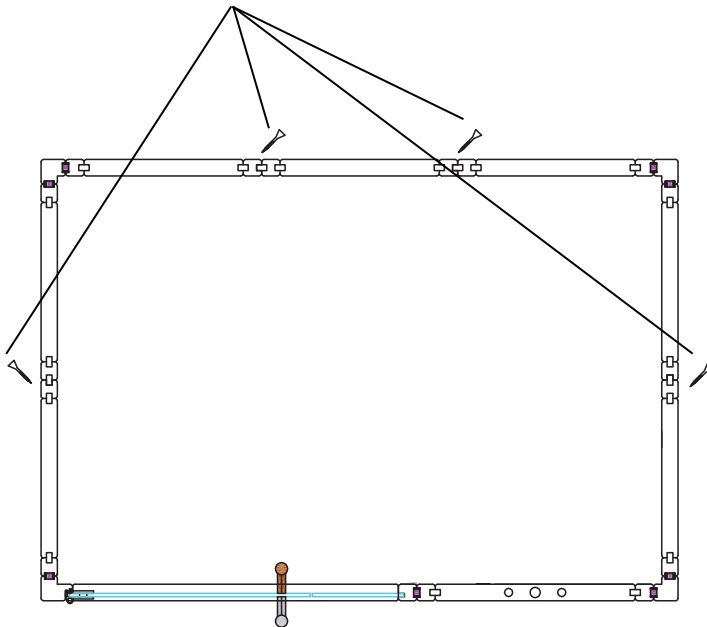

Suportes de canto e suportes para vidro



Elemento de vidro

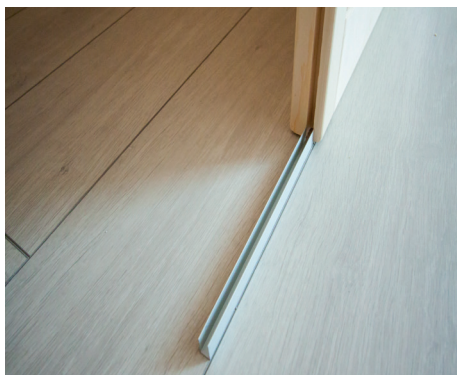

Elemento por cima da porta

Selecionar o elemento para o plano “à direita”





Broca de 3 mm, 2 parafusos de 4 x 70 mm

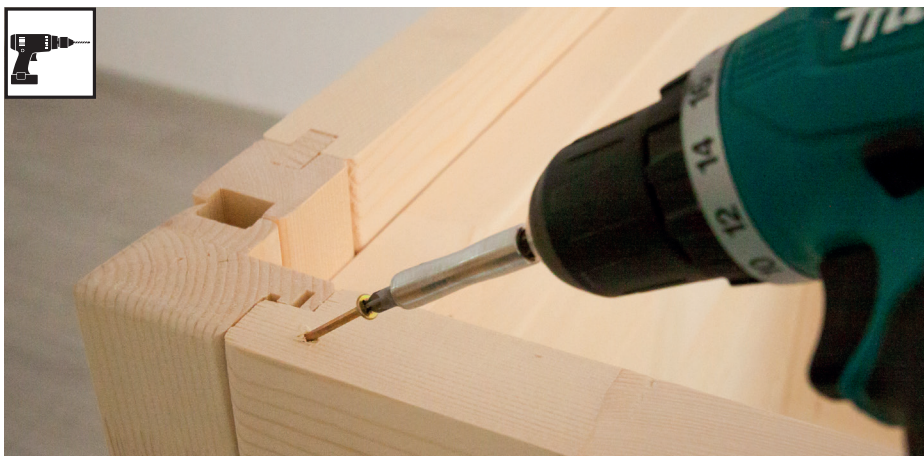

2.3. Montagem do teto

Barras de apoio para o teto



Broca de 3 mm, 12 parafusos de 4 x 70 mm



Elementos do teto

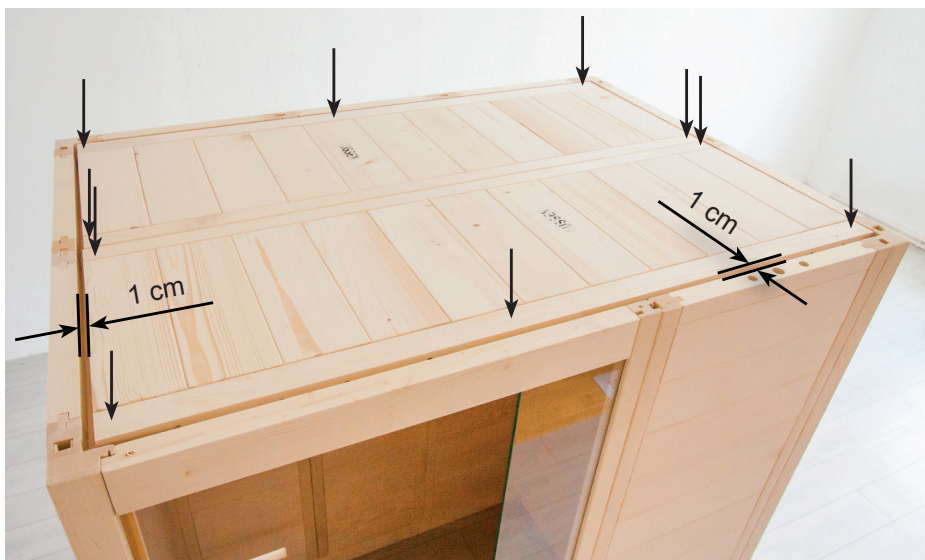

Broca de 3 mm, 10 parafusos de 4 x 70 mm

2.4. Montagem da corrediça de ventilação



Broca de 3 mm, 4 parafusos de 3 x 40 mm

2.5. Montagem do equipamento interior

Barras de apoio para o banco

Broca de 3 mm, 3 parafusos de 5 x 70 mm



2 parafusos de 4 x 60 mm

Broca de 3 mm, 3 parafusos de 5 x 70 mm



Parafusos de 4 x 60 mm

Anteparo do banco



4 parafusos de 4 x 60 mm

Banco



Degrau



6 parafusos de 4 x 70 mm



4 parafusos de 3,5 x 35 mm



Encosto



Broca de 3 mm, 3 parafusos de 3 x 40 mm

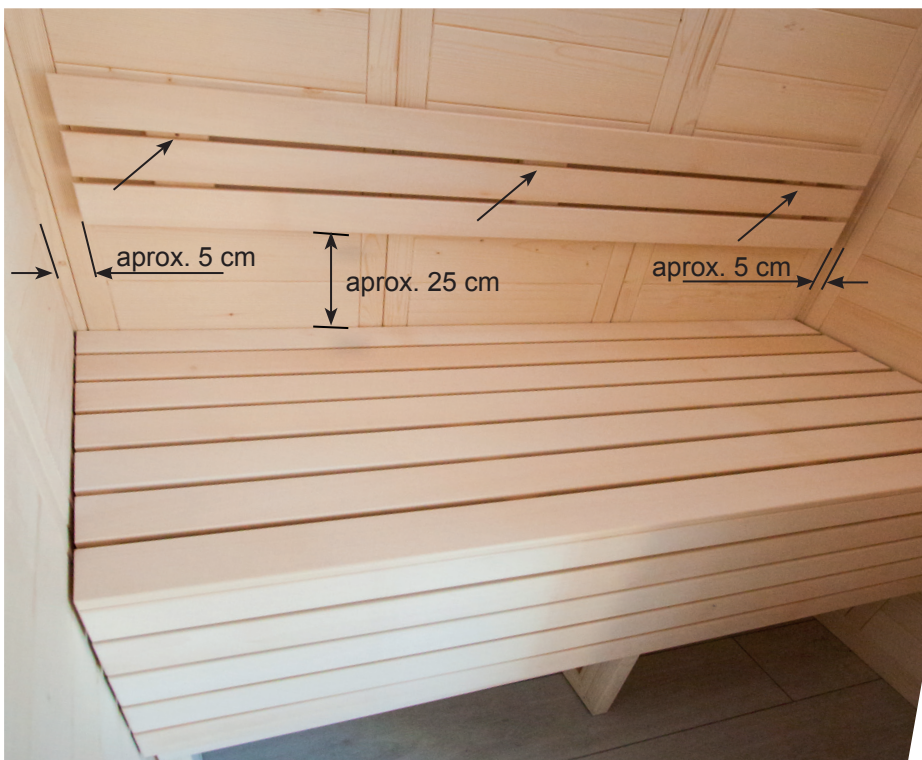

2.6. Montagem dos acessórios

Luz da sauna



Colocar a lâmpada
(não incluída no volume
de fornecimento)



Broca de 3 mm, 2 parafusos

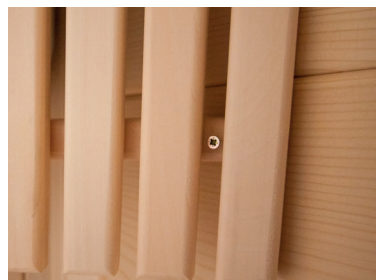

4 parafusos de 3 x 40 mm

Grelha de proteção do aquecedor

Antes de montar a grelha de proteção do aquecedor, faça um furo para a saída do cabo do aquecedor no elemento elétrico.



12 parafusos de 3 x 40 mm



Grelha de proteção do aquecedor encurtável individualmente

2.7. Montagem da porta de vidro



O furo inferior do puxador da porta encontra-se a 92,4 cm de altura.
O alinhamento das ferragens é efetuado através do ajuste/rotação de ambas as inserções de plástico.

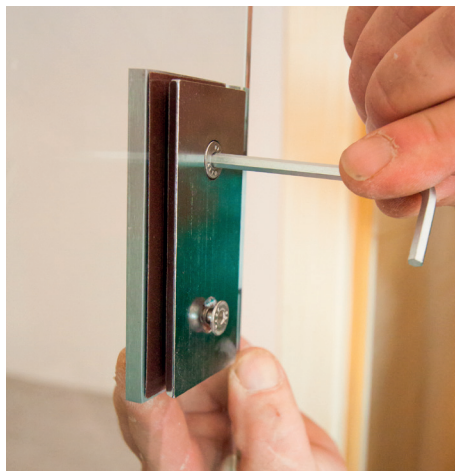
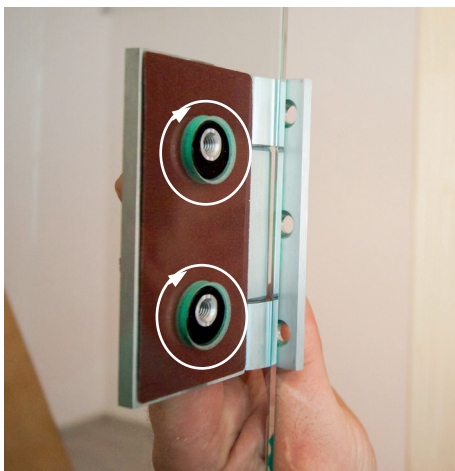

Puxador da porta e chapa de transferência

Os puxadores da porta são aparafusados entre si pelo interior.

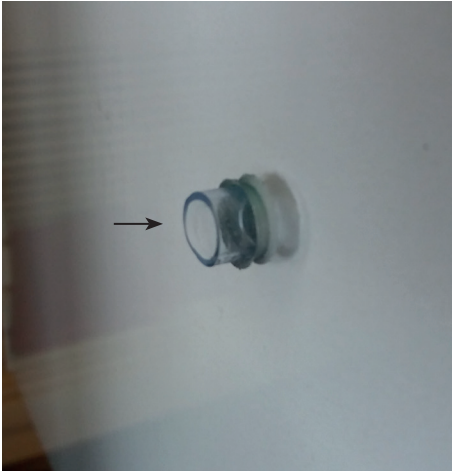

Colocar o anel de silicone nos orifícios



Inserir as anilhas planas de plástico no puxador de aço inoxidável



2.8. Montagem do friso do teto



Monte o friso do teto só depois de ter puxado os cabos para o aquecedor da sauna e para o controlo da sauna. A barra poderá ter de ser cortada junto do elemento elétrico.

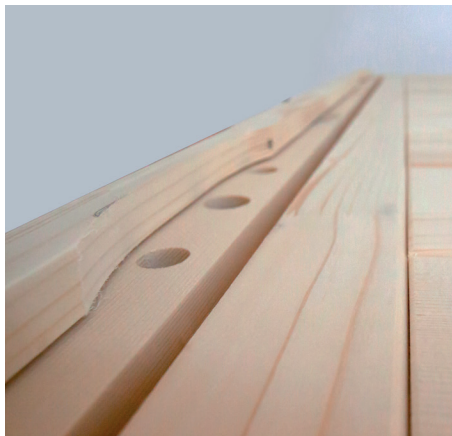

Broca de 3 mm, 9 parafusos de 3 x 40 mm

2.9. Montagem da barra de cobertura do teto



Monte a barra de cobertura do teto só depois de ter puxado os cabos para o aquecedor da sauna e para o controlo da sauna. A barra poderá ter de ser cortada junto do elemento eléctrico.



12 parafusos de 3 x 40 mm

3. Plano

3.1. Plano “à direita”

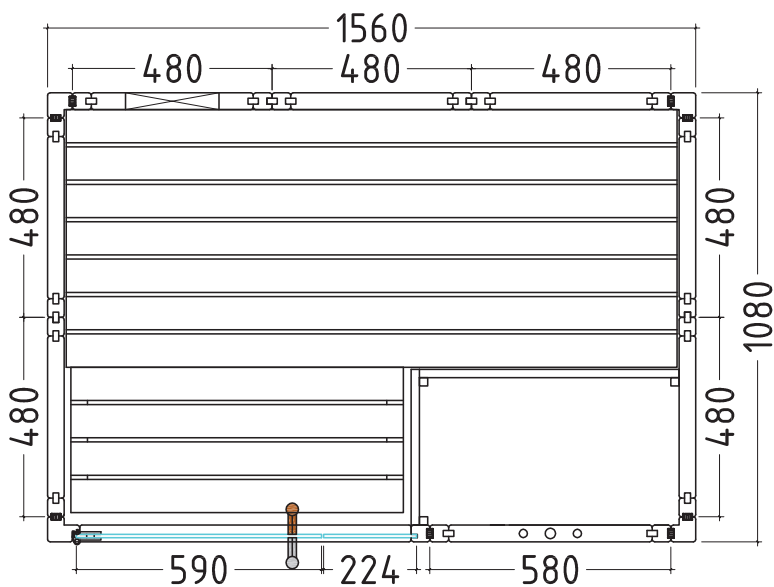

3.2. Plano “à esquerda”

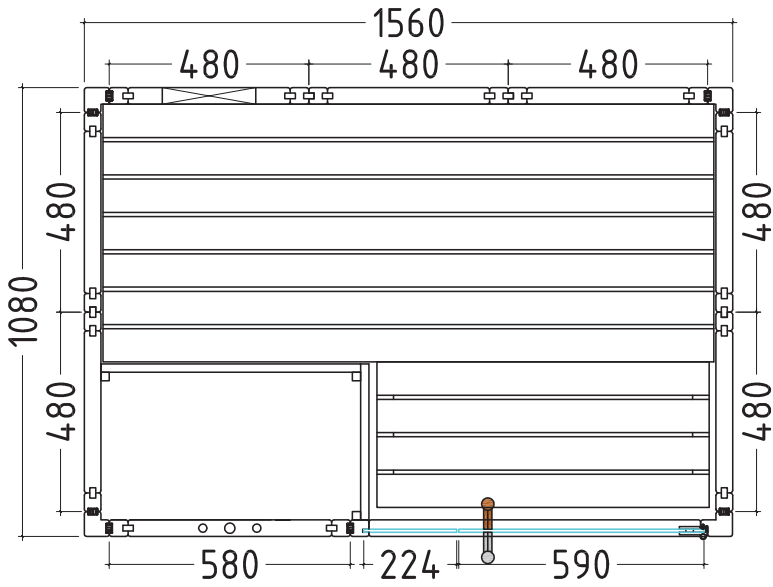

3.3. Alterações na montagem do plano “à esquerda”

Para a montagem dos suportes de canto e dos suportes para vidro (página 14)

Remova os multiclipos do suporte de canto e do suporte para vidro.

Utilize o molde fornecido para o reposicionamento dos multiclipos.



PT

Elemento por cima da porta (página 15)

Selecionar o elemento para o plano “à esquerda”





sentiotec GmbH | Division of Harvia Group | Oberregauer Straße 48, A-4844 Regau
T +43 (0) 7672/277 20-567 | F -801 | info@sentiotec.com | www.sentiotec.com



sentiotec GmbH | Division of Harvia Group | Oberregauer Straße 48, A-4844 Regau
T +43 (0) 7672/277 20-567 | F -801 | info@sentiotec.com | www.sentiotec.com